

SITE PREPARATION MANUAL

2000A

TIME-SHARED BASIC SYSTEM

HEWLETT  PACKARD

SITE PREPARATION MANUAL

2000A

TIME-SHARED BASIC SYSTEM

TABLE OF CONTENTS

Section	Page	Section	Page
I			
GENERAL SITE SPECIFICATIONS			
1-1. Introduction	1-1	1-36. Acoustics	1-9
1-3. System Organization	1-1	1-38. Illumination	1-9
1-4. Equipment	1-1	1-40. Ventilation	1-9
1-10. Layout	1-1	1-43. Interfacing Equipment Requirements . .	1-10
1-12. Power Outlets	1-1	1-47. Magnetic Tape Storage	1-10
1-14. Traffic Flow and Material Handling	1-7	1-51. Safety Precautions	1-11
1-15. Interconnecting Cables	1-7	1-52. Fire	1-11
1-16. Power Cables	1-7	1-56. Electrical	1-11
1-20. Signal Cables	1-7	1-58. Lightning	1-11
1-22. Building and Environmental Requirements	1-8	II	
1-24. Room Size	1-8	2-1. Introduction	2-1
1-27. Floor Type	1-9	2-3. Data Sheets	2-1
1-32. Temperature and Humidity	1-9	III	
1-34. Vibration	1-9	SYSTEM POWER DISTRIBUTION	
		3-1. Introduction	3-1
		3-2. Power Distribution Diagrams	3-1

LIST OF ILLUSTRATIONS

Figure	Title	Page	Figure	Title	Page
1-1.	Hewlett-Packard 2000A Time-Shared BASIC System	1-3	2-19.	HP 2753A Tape Punch	2-21
1-2.	Equipment Templates	1-5	2-20.	HP 2753A Tape Punch Outline Drawing	2-22
1-3.	Bell Telephone System 103E Data Station	1-7	2-21.	HP 2771A Disc Memory	2-23
1-4.	System Cabling and Ventilation	1-8	2-22.	HP 2771A Disc Memory Outline Drawing	2-24
2-1.	HP 2116B Computer	2-3	2-23.	HP 2773A Drum Memory	2-25
2-2.	HP 2116B Computer Outline Drawing	2-4	2-24.	HP 2773A Drum Memory Outline Drawing	2-26
2-3.	HP 12584A Teleprinter Multiplexor	2-5	2-25.	HP 2774A Drum Memory	2-27
2-4.	HP 12584A Teleprinter Multiplexor Outline Drawing	2-6	2-26.	HP 2774A Drum Memory Outline Drawing	2-28
2-5.	HP 2737A Tape Reader	2-7	2-27.	HP 2776A Power Supply	2-29
2-6.	HP 2737A Tape Reader Outline Drawing	2-8	2-28.	HP 2776A Power Supply Outline Drawing	2-30
2-7.	HP 2754B Teleprinter	2-9	2-29.	HP 2775A Drum Memory	2-31
2-8.	HP 2754B Teleprinter Outline Drawing	2-10	2-30.	HP 2775A Drum Memory Outline Drawing	2-32
2-9.	HP 2770A Disc Memory	2-11	2-31.	HP 2777A Power Supply	2-33
2-10.	HP 2770A Disc Memory Outline Drawing	2-12	2-32.	HP 2777A Power Supply Outline Drawing	2-34
2-11.	HP 2772A Power Supply	2-13	2-33.	HP 2150B Extender	2-35
2-12.	HP 2772A Power Supply Outline Drawing	2-14	2-34.	HP 2150B Extender Outline Drawing	2-36
2-13.	HP 2160A Power Supply	2-15	2-35.	HP 2778A Line Printer	2-37
2-14.	HP 2160A Power Supply Outline Drawing	2-16	2-36.	HP 2778A Line Printer Outline Drawing	2-38
2-15.	HP 2749A Teleprinter	2-17	2-37.	HP 2992Z Two-Bay Cabinet	2-39
2-16.	HP 2769A Teleprinter Outline Drawing	2-18	2-38.	HP 2992Z Two-Bay Cabinet Outline Drawing	2-40
2-17.	HP 3030G Digital Tape Unit	2-19	2-39.	HP 2866A Extender Cabinet	2-41
2-18.	HP 3030G Digital Tape Unit Outline Drawing	2-20	2-40.	HP 2866A Extender Cabinet Outline Drawing	2-42
			3-1.	HP 2992Z Two-Bay Cabinet Wiring Diagram	3-2
			3-2.	HP 2866A Extender Cabinet Wiring Diagram	3-3

LIST OF TABLES

Table	Title	Page	Table	Title	Page
1-1.	Data Station Strapping Options	1-10	2-10.	HP 2753A Tape Punch Specifications	2-21
2-1.	HP 2116B Computer Specifications	2-3	2-11.	HP 2771A Disc Memory Specifications	2-23
2-2.	HP 12584A Teleprinter Multiplexor Specifications	2-5	2-12.	HP 2773A Drum Memory Specifications	2-25
2-3.	HP 2737A Tape Reader Specifications	2-7	2-13.	HP 2774A Drum Memory Specifications	2-27
2-4.	HP 2754B Teleprinter Specifications	2-9	2-14.	HP 2776A Power Supply Specifications	2-29
2-5.	HP 2770A Disc Memory Specifications	2-11	2-15.	HP 2775A Drum Memory Specifications	2-31
2-6.	HP 2772A Power Supply Specifications	2-13	2-16.	HP 2777A Power Supply Specifications	2-33
2-7.	HP 2160A Power Supply Specifications	2-15	2-17.	HP 2150B Extender Specifications	2-35
2-8.	HP 2749A Teleprinter Specifications	2-17	2-18.	HP 2778A Line Printer Specifications	2-37
2-9.	HP 3030G Digital Tape Unit Specifications	2-19	2-19.	HP 2992Z Two-Bay Cabinet Specifications	2-39
			2-20.	HP 2866A Extender Cabinet Specifications	2-41
			2-21.	System Accessories	2-43

SECTION I

GENERAL SITE SPECIFICATIONS

1-1. INTRODUCTION.

1-2. The purpose of this manual is to provide the customer with detailed information to prepare a site for the installation of a Hewlett-Packard 2000A Time-Shared BASIC System. The customer must provide suitable space, electrical power, required interfacing equipment, and make other provisions to ensure that the site will be suitable for system installation. In many cases, the customer will find it advisable to establish a consulting schedule with the Hewlett-Packard sales representative to ensure that the facilities are ready when the system is delivered. This manual describes the physical and electrical requirements of the system; the methods by which these requirements are met are the responsibility of the customer. This section contains general site specifications. Section II contains specific data on the equipment that comprises the system. Section III contains power distribution diagrams for the system.

1-3. SYSTEM ORGANIZATION.

1-4. EQUIPMENT.

1-5. The time-shared BASIC system is a self-contained computer system. Figure 1-1 shows a typical configuration. The system consists of equipment mounted in cabinets, free standing equipment, and teleprinters which are either cabled directly to the system or are connected to the system over telephone lines. The method of interfacing the teleprinters with the equipment is a prime consideration in determining the site requirements. An additional single-bay floor-mounted cabinet may be included in the system to provide an extension of core memory to 32K and provide additional input/output capability for the computer.

1-6. The main double-bay computer cabinet (HP 2992Z) contains the central processor unit (HP 2116B Computer) and other functional units including the tape punch, the tape reader, the rotating memory unit, and the power supplies. The cabinet is supported by four casters and two leveling jacks in the front of the cabinet that provide additional support after the cabinet has been rolled into a permanent location.

1-7. The optional single-bay cabinet may be added to the system to extend the basic memory and input/output capability of the system. The cabinet is normally equipped with an HP 2150B Extender. The cabinet is one-half the width of the main computer cabinet and must be located directly adjacent and to the left of the main cabinet (as viewed from the front).

1-8. The system also includes various arrangements of teleprinters and data sets, the exact arrangement of which will depend upon how the customer expects to utilize the system. If the teleprinters are connected to the system over telephone lines, any number of users can have access to the system, with a maximum of 16 able to operate simultaneously.

1-9. Overall dimensions of a typical system, including an extender cabinet, are shown in figure 1-1. A minimum clearance of 2 feet must be maintained around the cabinets to permit opening of doors. (See figure 1-2.) Also, 2 feet of ceiling clearance is required to allow the exhaust fans in the tops of the cabinets to function properly. In addition to the equipment shown in figure 1-1, a data station is required for operating the system with telephone lines. (See figure 1-3.) The 103E Data Station must be ordered from the telephone company. The cabinet that houses the complete data station is 34 inches wide, 30-1/2 inches deep, and 72 inches high. Clearance of 25 inches must be provided in both the front and the rear of the data station cabinet to permit the opening of cabinet doors for servicing.

1-10. LAYOUT.

1-11. It is the responsibility of the customer to determine a suitable layout for the system components prior to delivery. The layout will be affected by considerations such as the specific components included in the system, size and shape of the computer area, and aesthetic appearance. Physical dimensions of the system components are provided in figure 1-1, and scaled plan-view drawings are provided in figure 1-2 for the cabinets. The plan view drawings may be cut out and set on a plan view of the proposed computer area to provide sample layouts. In each case in figure 1-2, the front of the equipment is towards the bottom of the page. Grid paper drawn to the same scale as the equipment templates is provided at the end of this manual for drawing sample layouts.

1-2. POWER OUTLETS. The customer shall provide adequate power outlets for the system as required for his particular configuration. (See figures 3-1 and 3-2.) The system requires either a 115-volt, 60-Hertz outlet, a 220-volt, 4-wire, 60-Hertz outlet, or a 3-phase, 120/208-volt, 60 Hertz outlet. The 120/208-volt outlet is required if the HP 2775 Drum Memory and associated HP 2777A Power Supply are used in the system. Otherwise, either the 115-volt or the 220-volt power outlet may be used. Also, 230-volt, 50-Hertz power is optional to the system. The cable for the system power is to be furnished by the customer and must comply with local electrical codes. The teleprinter(s) also require a 115-volt, 60-Hertz

NOTES:

1. ALL DIMENSIONS ARE IN INCHES.
2. IF A DRUM MEMORY IS USED, THE DRUM IS MOUNTED IN A BAY BY ITSELF OR WITH THE DRUM MEMORY POWER SUPPLY IN THE TOP OF SAME BAY WITH THE DRUM. NO OTHER DEVICE CAN BE MOUNTED IN THE SAME BAY AS THE DRUM BECAUSE OF HEAT DISSIPATION REQUIREMENTS.
3. THE MAIN CABINET AND EXTENDER CABINET CONFORM TO 19 INCH WIDTH PANEL MOUNTING PER ELECTRONIC INDUSTRIES ASSOCIATION (EIA) STANDARD FOR RACKS, PANELS, AND ASSOCIATED EQUIPMENT.

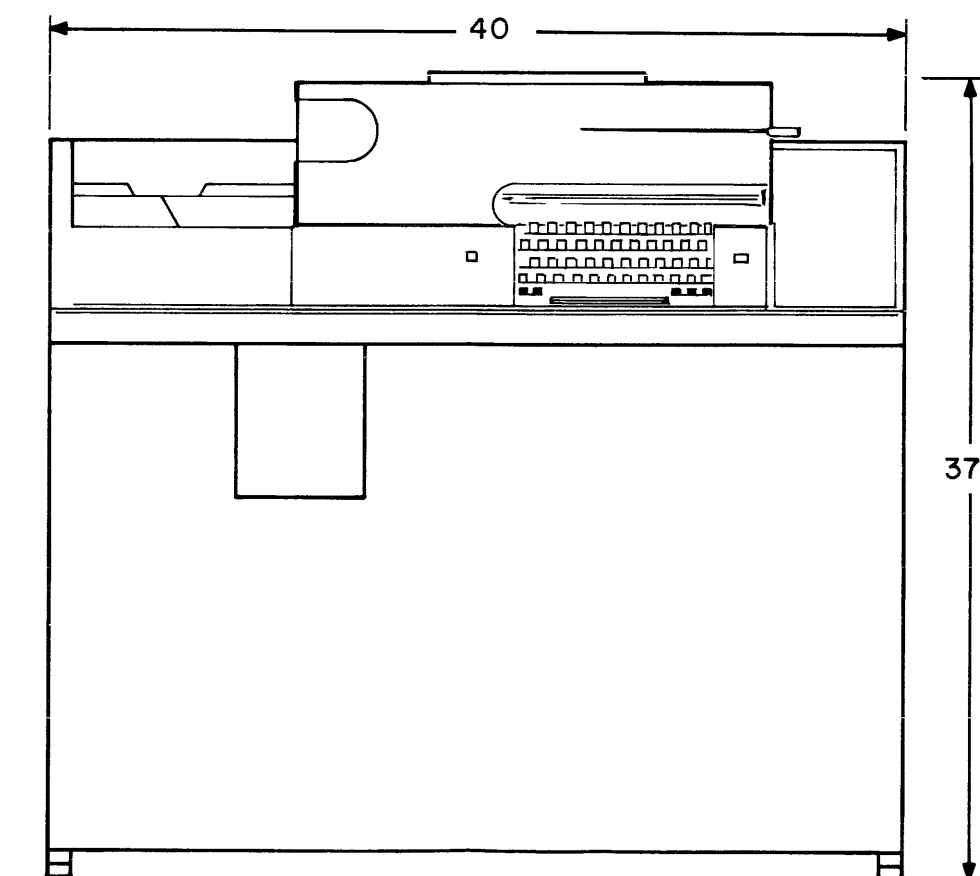
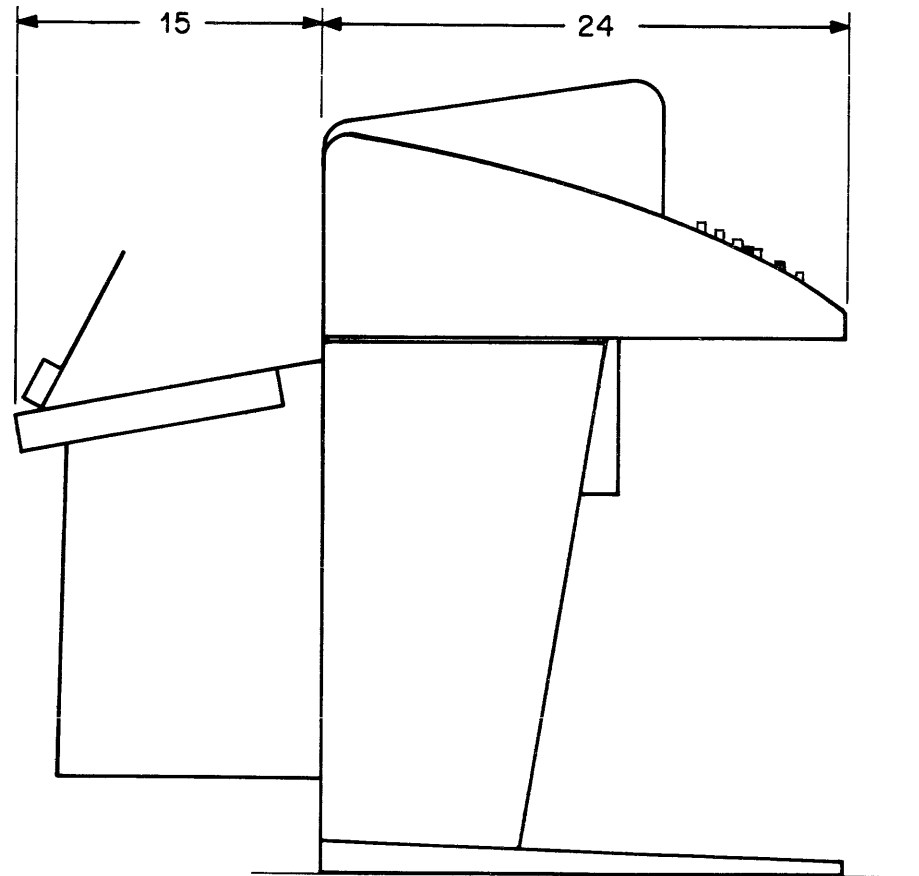

TELEPRINTER

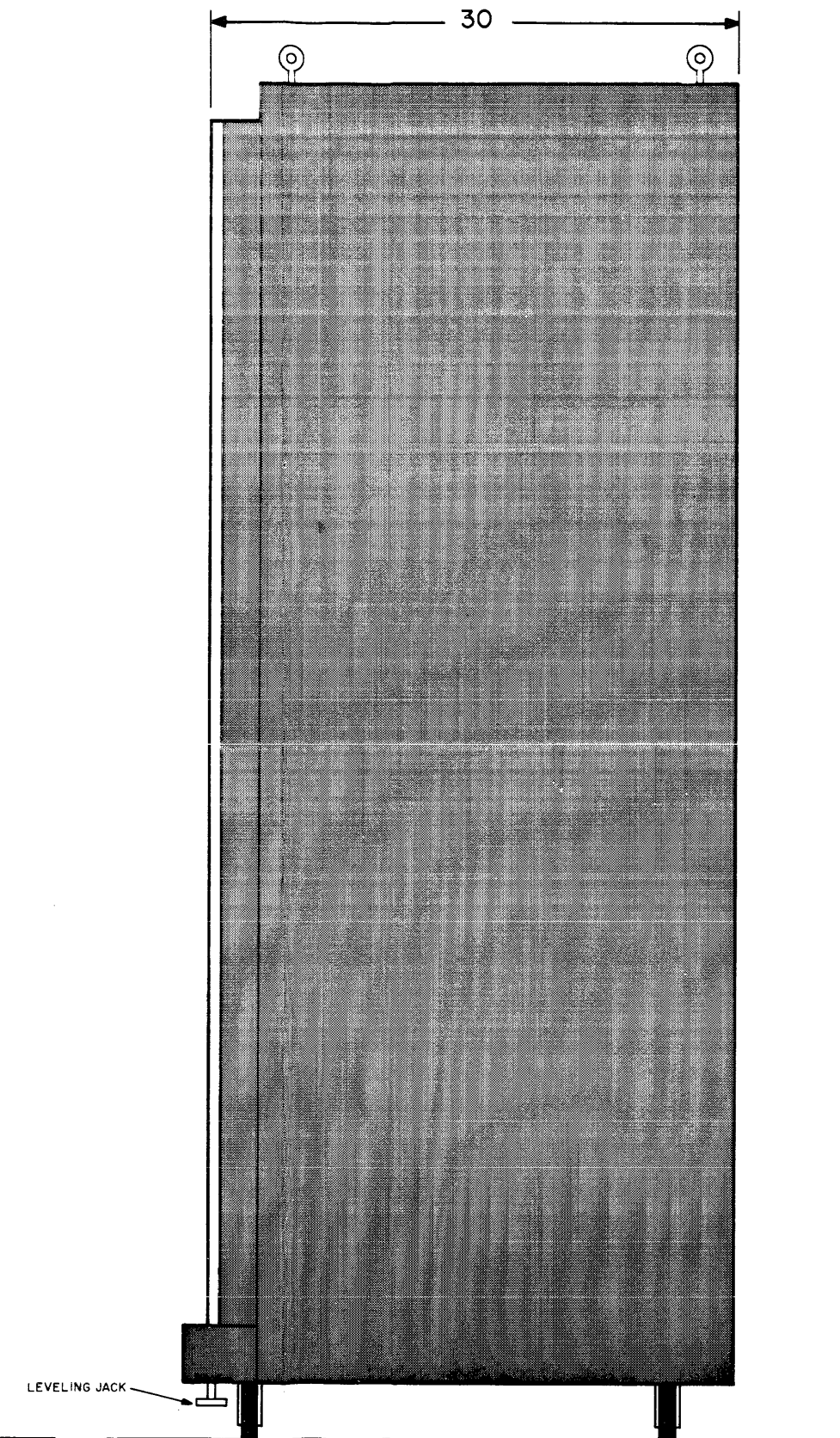

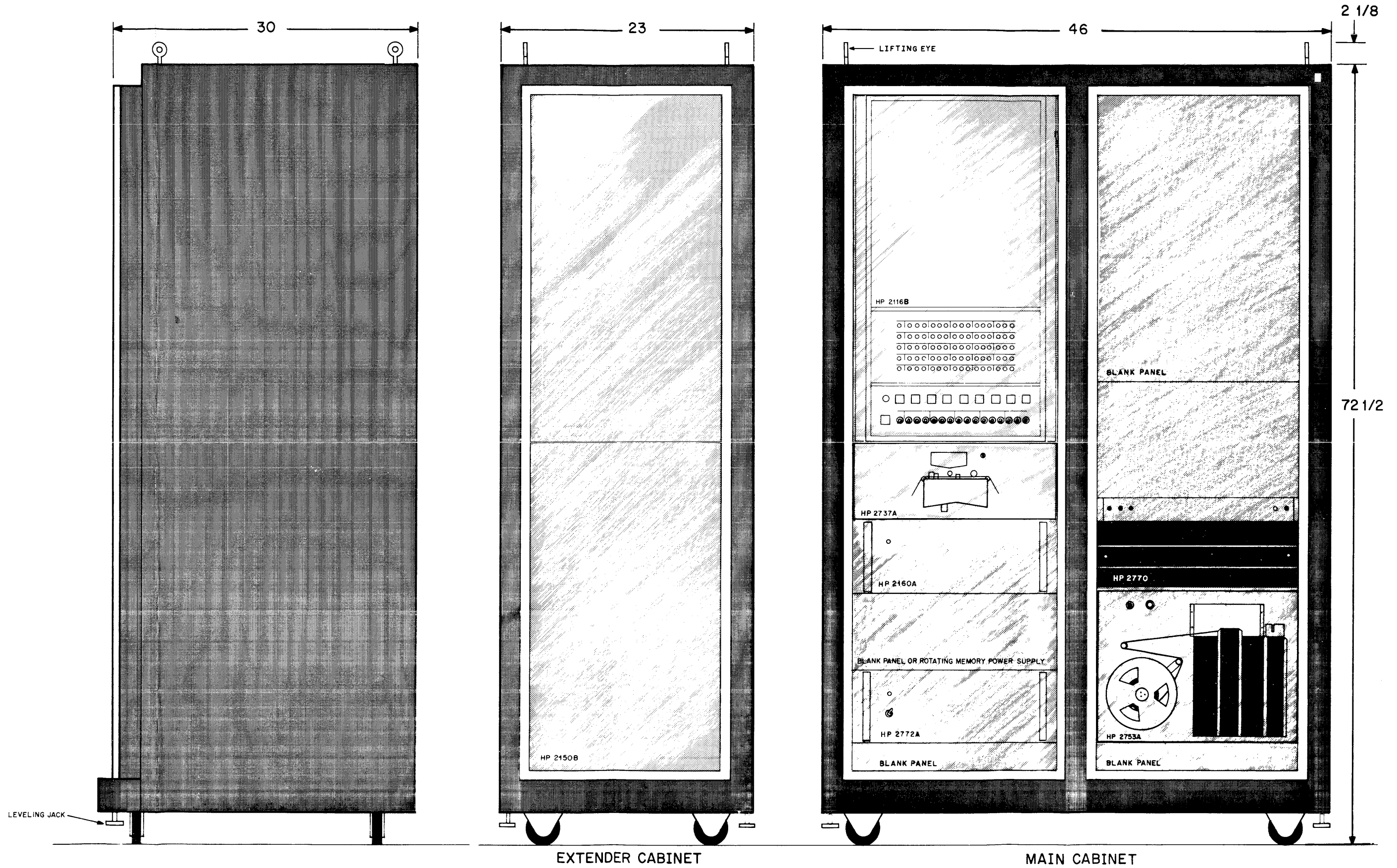
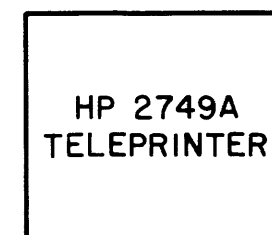
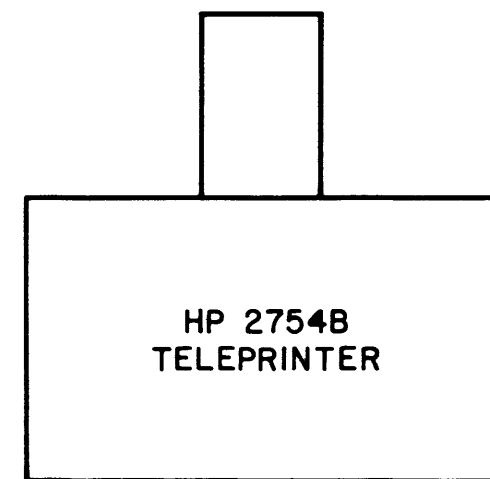
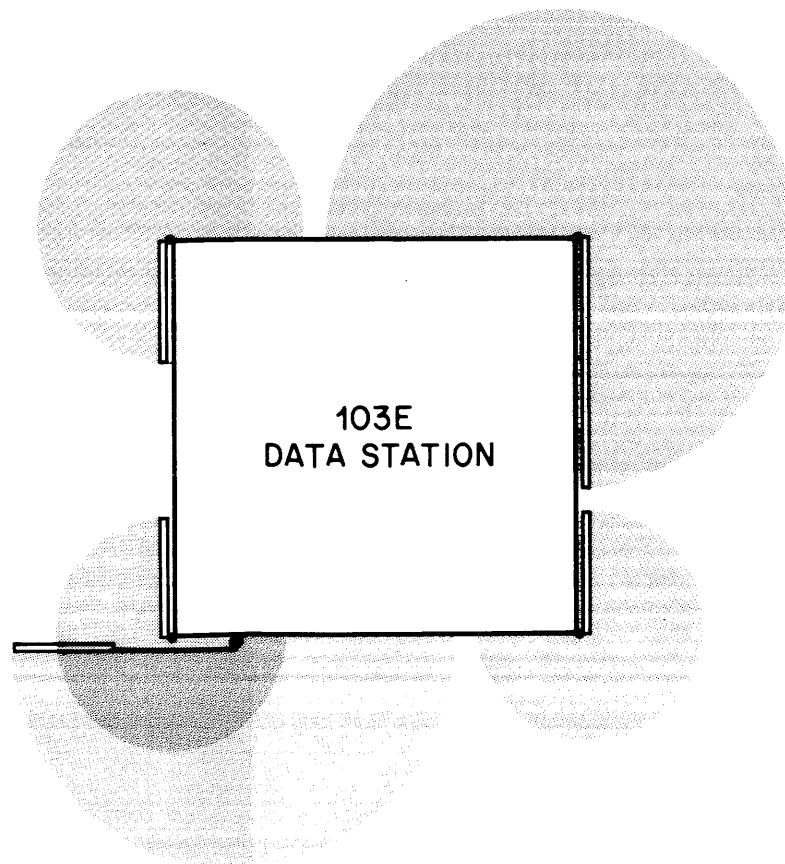
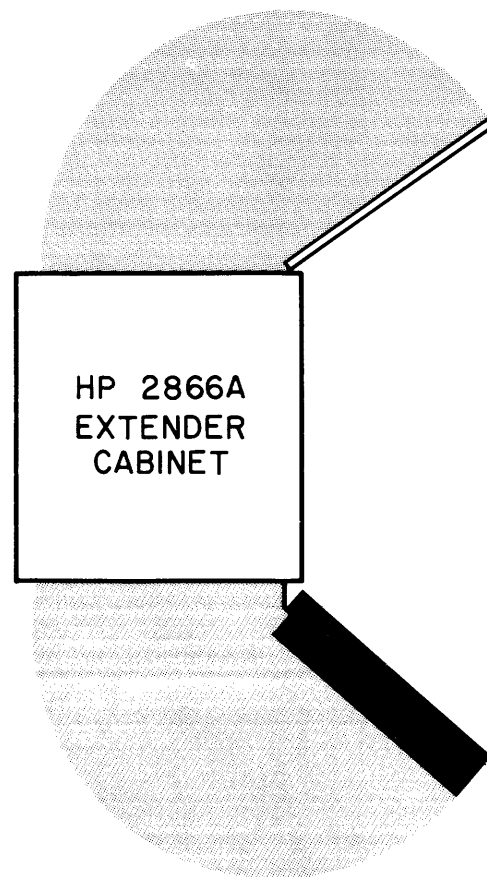
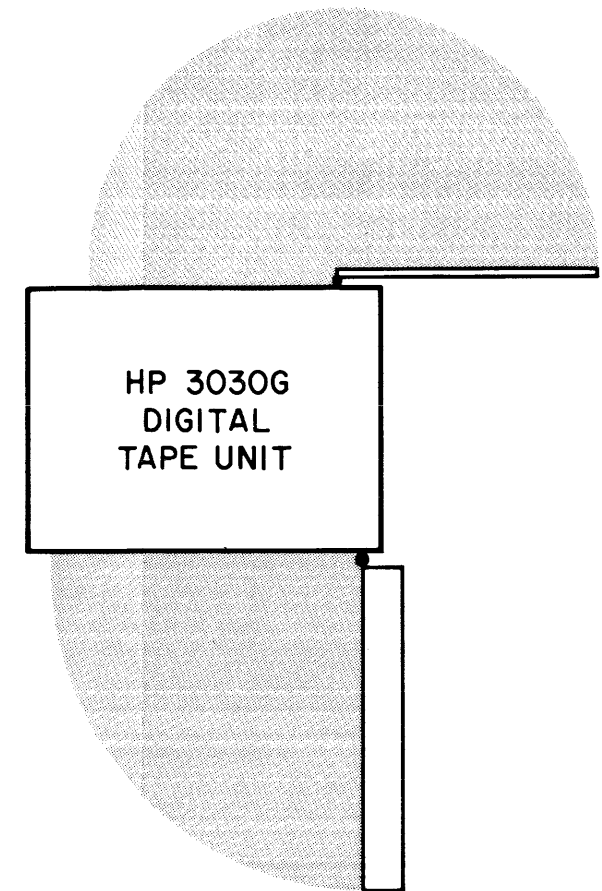
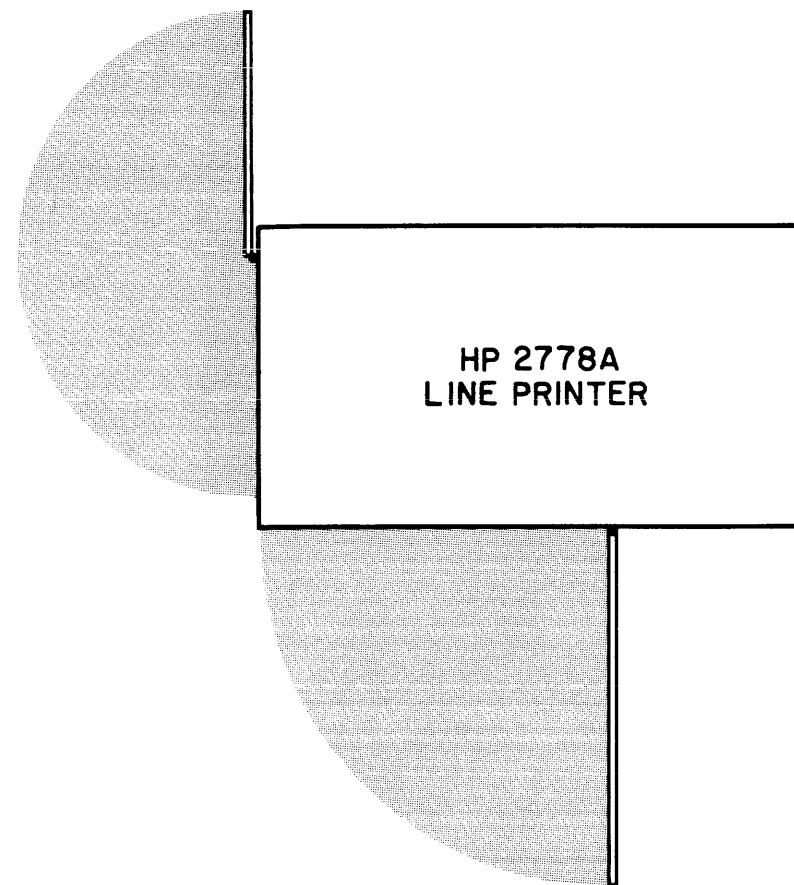
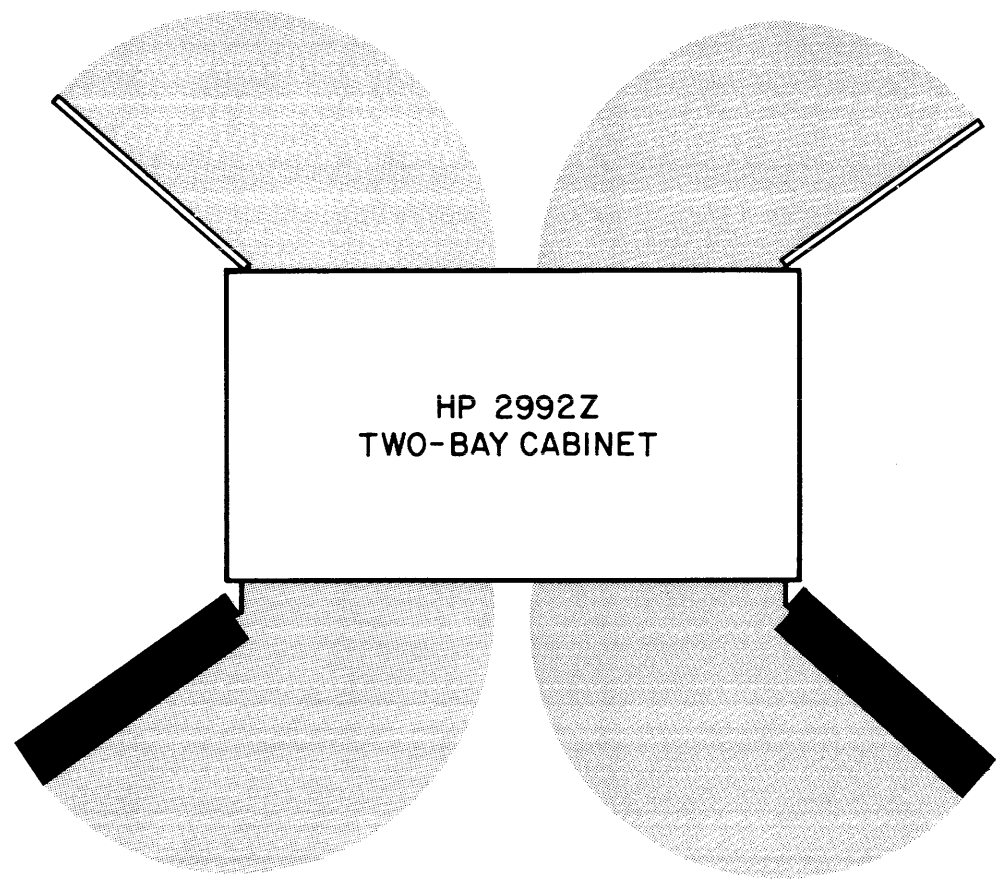

Figure 1-1. Hewlett-Packard 2000A Time-Shared BASIC System



SCALE: 1/16" = 1"

outlet. The data station requires a single 115-volt \pm 10 percent, 60 \pm 0.1 Hertz outlet. All 115-volt outlets should be single-phase grounded type receptacles. The data station requires 520 watts of power. Refer to section II for current requirements of the other equipment in the system.

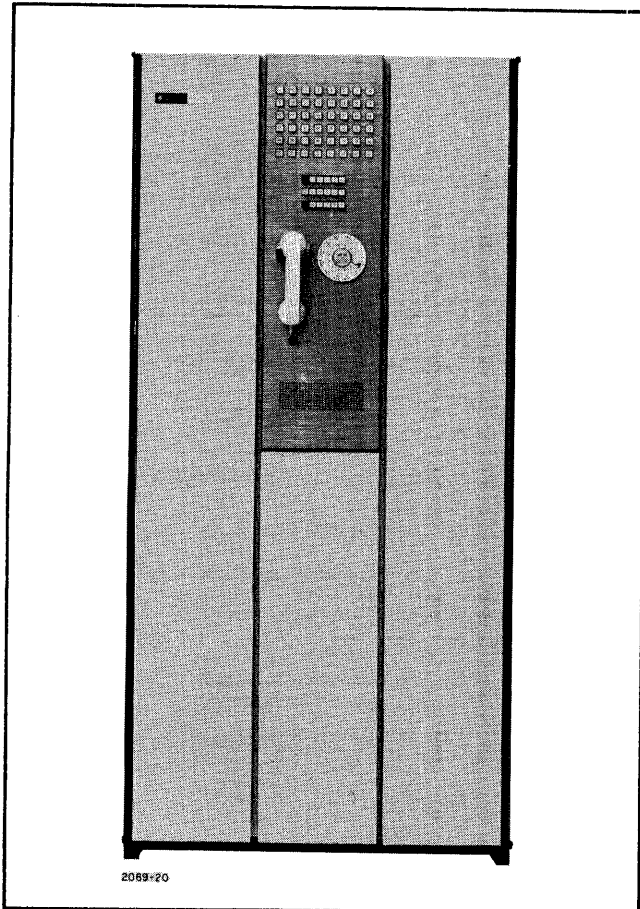

Figure 1-3. Bell Telephone System 103E Data Station

1-13. Several 115-volt ac convenience outlets are provided inside the rear doors of the computer cabinets on strips which may be used for connecting maintenance equipment, etc. Equipment that generates line noise, such as vacuum cleaners, must not be connected to these outlets or damage to the system may result. The maximum current that may be taken from each of the convenience outlet strips is 20 amperes. Additional convenience outlets should be provided in the equipment vicinity for building maintenance and any other anticipated general needs. The convenience outlets may be located in the perimeter walls and/or in raised floor panels. The receptacles must be of the single-phase grounded type and should be connected to the building power system. The receptacles and wiring must comply with local electrical codes. For 60-Hertz installations, the nominal voltage at the convenience outlets should be 115 volts. For 50-Hertz installations, the nominal voltage should be 230 volts.

1-14. **TRAFFIC FLOW AND MATERIAL HANDLING.** The work flow to and from the system should be considered when the location of equipment is planned.

Sufficient aisle space should be provided for the movement of carts and personnel. Storage and file areas should be located to minimize travel time. Adequate space must be allowed for waste and take-up containers.

1-15. INTERCONNECTING CABLES.

1-16. POWER CABLES.

1-17. The ac power cable to the main computer cabinet is to be furnished by the customer. (See figure 1-4 for cabinet cable access holes.) The power cable may be either three-wire, four-wire, or five-wire, depending on the type of ac service the particular system configuration requires. For 115-volt ac service a 3-conductor power cable is used. A 4-conductor cable is used for 220-volt ac service. A 5-conductor cable is used for 120/208-volt, 3-phase ac service. In each case, the conductors are to be at least number 12 AWG stranded wire and should be solder-tinned at the terminating end before connecting to the terminal block on the system. The maximum wire size that can be terminated on the terminal block is number 8 AWG stranded. For the 115-volt and 220-volt configurations, the unused terminals on the terminal block are to be strapped during installation of the system. See figure 3-1 for the exact power connections to be made. This diagram also appears on the inside of the right-hand rear door of the main cabinet.

1-18. If an extender cabinet is added to the system, the power for the cabinet is provided by the main cabinet. A cable will be provided by Hewlett-Packard for the extender cabinet. This cable will be of sufficient length to reach from the convenience outlet strip in the main cabinet to the terminal block in the extender cabinet (normally, about 5 feet). Access to the convenience outlet strip in the main cabinet is through the signal-cable access hole in the rear of the cabinet.

1-19. There is no critical length for the power cables. The only requirement is that the voltage drop is small enough to maintain the 10 percent voltage tolerance specified for the system.

1-20. SIGNAL CABLES.

1-21. The signal cables for tying the data sets to the telephone lines and the power cable for the data station are provided and connected by the telephone company. The interfacing cables that tie the data sets to the system may be ordered from Hewlett-Packard by specifying part no. 12584-6006, and are installed by connecting one end to the data set connector and the other end to the teleprinter multiplexor inside the rear of the cabinet. (See figure 1-4 for signal-cable access holes.) The maximum length of these cables is 25 feet. Cables are also available to connect the teleprinters directly to the teleprinter multiplexor. These cables are normally 25 feet in length (part no. 12584-6007) but may be specially ordered in lengths up to 1 mile. Install these cables away from video cables, control cables, and other noise radiating cables.

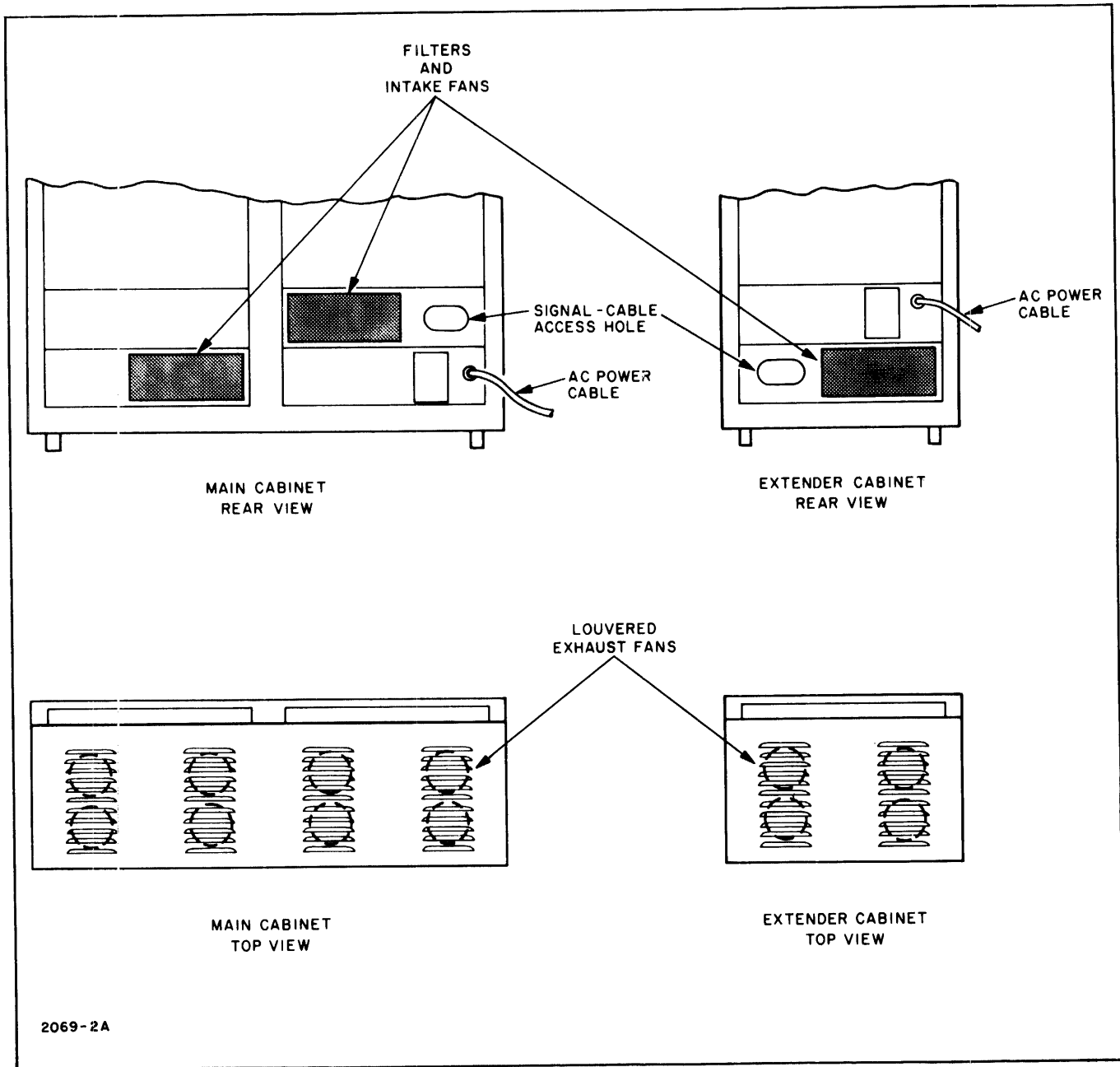

Figure 1-4. System Cabling and Ventilation

1-22. BUILDING AND ENVIRONMENTAL REQUIREMENTS.

1-23. The site chosen to house the system should meet the space and convenience requirements of the present layout as well as provide space for future expansion. The following paragraphs outline specific requirements to be considered in planning and preparing a suitable site for the equipment.

1-24. ROOM SIZE.

1-25. The room size should be such that the equipment is easily accessible from both the front and rear. (A minimum of 2 feet of clearance is required in the front and

rear of the equipment.) Ceiling height should be at least 9 feet to provide an area above the cabinets for exhaust ventilation. Physical dimensions of the equipment are provided in section II, and equipment templates are provided in figure 1-2. Grid paper is included at the end of this manual with 1-foot square grids at the same scale as the equipment templates. The grid paper and the equipment templates can be used to establish sample floor plans.

1-26. The customer should make certain that all doors, elevators, and passageways that the equipment must pass through enroute to the desired location are large enough. The disc or drum memory for the system is not shipped

installed in the system. The unit must be installed after the system cabinet(s) are in place in the computer area and the leveling jacks on the cabinet have been fully extended to provide the necessary support. Therefore, the room must accommodate a fork-lift or crane of adequate size to install the rotating memory. The lift must be capable of lifting the memory unit to a height of 6 feet. The rotating memory must be lifted from the top using the Hewlett-Packard lifting kit, and must not be tilted more than 6 degrees from the vertical during or after installation.

CAUTION

The leveling jacks for the cabinet must be extended before the memory unit is installed or the weight of the memory unit may tip over the cabinet during installation.

1-27. FLOOR TYPE.

1-28. Tile, concrete, or other industrial floors as well as raised floors are all adequate for system installation. Concrete floors should be treated to prevent excessive dust. Special wiring arrangements or covers should be used to protect power wiring and signal cables. If a raised floor is used, the cables may be run beneath the floor panels. When a new computer room is constructed, it is advantageous to install the computer room floor 6 to 12 inches lower than the normal building floor. A raised floor can then be installed flush with the building floor, eliminating the need for ramps.

1-29. If a raised floor is to be used with the system, the floor should have the following characteristics:

- a. An elevation of 6 to 12 inches above the normal floor.
- b. Square flooring panels no more than 2 feet by 2 feet.
- c. Panels constructed of metal or metal-clad wood.
- d. Panels covered by a floor covering such as vinyl tile.

1-30. A raised floor enables relatively unrestricted routing of cables beneath the floor surface and eliminates the problem of covering the exposed wires and cables that would otherwise lie on the floor surface. A suitably constructed raised floor permits equipment layouts to be changed more readily and enhances the appearance of the computer area.

1-31. The floor should be level within 1/16 inch per 5 feet. When calculating floor loading, refer to section II for equipment weights. The data station weighs 1033 pounds. If a raised floor is used, include the weight of the raised floor when calculating primary floor loading. Since the weight of the equipment in the cabinets is concentrated over the casters, the floor must withstand a concentrated

load of 300 pounds per square inch over an area of 4.12 square inches. Also, the floor must withstand the weight of the fork lift or other equipment that is used to install the rotating memory.

1-32. TEMPERATURE AND HUMIDITY.

1-33. It is the responsibility of the customer to make certain that the environment of his proposed location meets the requirements of the system. The time-shared BASIC system is designed to operate with a minimum of environmental restrictions. In general, the system can operate in any environment suitable for human occupancy as long as moisture condensation does not occur. For maximum reliability and longest component life, operating temperatures should be held in the range of 10° to 30°C (50° to 86°F). The ambient temperature should not change more than 10°C per hour or condensation may result. Relative humidity (with no condensation) should be less than 80 percent within the recommended temperature range.

1-34. VIBRATION.

1-35. The time-shared BASIC system will withstand sustained vibration up to 0.15G, where G is the unit of gravitational acceleration. The number N of G's of acceleration may be calculated from the following formula:

$$N = 0.103 AF^2$$

where F is the frequency in Hertz and A is the amplitude of vibration, measured as displacement in inches from the mean.

1-36. ACOUSTICS.

1-37. The principal source of noise in the computer area is electro-mechanical devices such as teleprinters and tape punches. Although not essential for system operation, the user may consider it desirable to acoustically treat the computer area. For best results, an acoustical consultant should be engaged if it is desired to completely soundproof the computer room. In most instances, very satisfactory results can be obtained by acoustically treating the ceiling of the computer room. This will eliminate a large percentage of noise from the computer area, and acoustic ceiling tile enhances the appearance of the area.

1-38. ILLUMINATION.

1-39. An average of 50 to 75 foot-candles of total illumination measured 30 inches above the floor should be maintained in the computer area. For optimum visibility of lighted indicators, brilliant illumination should be avoided. Direct sunlight is not recommended.

1-40. VENTILATION.

1-41. The only requirement for room ventilation is that the ventilation system must be adequate to maintain the temperature and humidity restrictions presented in paragraph 1-32. Refer to section II for a complete listing of

system component heat dissipations. The heat dissipation for the 103E Data Station is 1780 BTU/hour. This information may be used to calculate the room ventilation requirements. An air conditioning consultant can make recommendations for room ventilation based on these figures and the general characteristics of the proposed computer area.

1-42. Ventilation for the main computer cabinet is provided by four intake fans in the lower rear of the cabinet and eight exhaust fans on the top of the cabinet. (See figure 1-4.) The extender cabinet has two intake fans in the lower rear and four exhaust fans on top of the cabinet. These fans direct air at room temperature into the lower rear of the cabinets, cool the system components, and exhaust the hot air out the tops of the cabinets. Each fan is rated at 100 cubic feet per minute. Filters are provided for all of the intake fans. These filters must be cleaned periodically with compressed air. The cleaning interval depends on the environmental conditions. A dusty area will require more frequent cleaning than a clean area. However, the filters should be cleaned at least once every two weeks.

1-43. INTERFACING EQUIPMENT REQUIREMENTS.

1-44. The standard interface between the system and the telephone switching network is the Bell Telephone System 103E Data Station. (See figure 1-3.) The data station houses up to eighteen 103E Data Sets (including two spares) for the sixteen time-shared lines. The data station cabinet also includes:

- a. One 804J1 Data Auxiliary Set (rotary dial).
- b. One 1A1 Data Mounting Unit.
- c. Five 2A1 Data Mounting Units.

d. One KS 20093 L-1 Cabinet and a KS 20129 AC Power Strip.

1-45. The data station is arranged for computer-make and release-busy via interface leads. Telephone numbers may be requested from the telephone company as required. The data station weighs 1033 pounds and the cabinet is 34 inches wide, 30-1/2 inches deep, and 72 inches high.

1-46. The telephone company is responsible for installing the data station, including making the necessary power connections, connecting intra-bay cabling, and making appropriate strapping options. Table 1-1 contains a list of the strapping options to be made on the data station. Hewlett-Packard field personnel will connect the data station to the system.

1-47. MAGNETIC TAPE STORAGE.

1-48. In determining the layout of the computing system, the user should consider requirements for storage of magnetic tape. Storage facilities should be provided if the system will be utilizing a magnetic tape unit. Steel storage bins should be provided in which the tape reels may be stored vertically with a partition between reels. Extremes of temperature and humidity should be avoided. Recommended storage conditions for acetate and polyester base tapes are:

40 to 60 percent relative humidity

15.5° to 26.6°C (60° to 80°F) temperature

1-49. If environmental extremes should occur, the tape should be brought to ambient conditions before use. The time required for tape reconditioning will usually vary from

Table 1-1. Data Station Strapping Options

BELL TELEPHONE SYSTEM CIRCUIT DESIGNATION	OPTION	CARD DESIGNATION	SCREW NO. AND POSITION
X	Answer mode indication CE on	C9	1 out 2 in
V	Space disconnect long	C10	8 in
T	Send Disconnect	C10	1 in
Q	Common ground	C9	10 in
N	Without answer/organization transfer	C10	10 in
M	Answer control combined	C9	9 in
B	CB and CF indication separate	C9	4 and 6 out 5 and 7 in

4 to 16 hours, depending on conditions to which the tape was subjected. Direct heat, such as lamps or heating coils, should not be used to heat a tape. Fewer errors will occur if the tape storage area is maintained at the same temperature and humidity as the area where the magnetic tape transport is located.

1-50. The reels of tape should be stored in self-sealing cases for protection from dust and severe environmental changes. It is recommended that tape be rewound once or twice a year in order to release stresses due to expansion or contraction. Tape should not come in contact with any magnetic material, and reels should not be stored in a cabinet having magnetic latches. Any magnetic field intensity greater than 50 oersteds can cause loss of information on the tape.

1-51. SAFETY PRECAUTIONS.

1-52. FIRE.

1-53. All printed-circuit cards used in the system are manufactured from flame retardant material. The material is self-extinguishing and represents a minimal fire hazard. Normal fire precautions should be observed within the computer area. Wall-mounted CO₂ fire extinguishers in the computer area are recommended.

1-54. The supply of paper in the computer area should be limited to that required for efficient operation. All other paper should be stored in an adjacent area. Waste paper should not be allowed to accumulate and should be collected in metal baskets.

1-55. Automatic sprinkler systems are recommended in the computer area as a fire precaution. Complete information on the sprinkler systems can be obtained from local contractors. Such systems must conform to local codes and insurance regulations. The sprinkler heads should be arranged so that when the sprinklers are activated, water will not be thrown directly into the system. Also, the sprinkler heads should not be located directly over the system cabinets or heat from the cabinets may activate the heads.

1-56. ELECTRICAL.

1-57. All equipment is grounded through the power cord and should not normally represent a shock hazard. When working on the equipment from the rear of the cabinets, it is recommended that rubber mats or insulated rubber-soled shoes be used as a precaution. All wiring and electrical outlets must conform to local electrical codes and should be inspected prior to system installation for proper grounding, voltage, and phasing.

1-58. LIGHTNING.

1-59. In many cases it is advisable that the user install lightning protectors in the computer power distribution system, both as a protection against damage to electronic components from power line surges and as a fire prevention measure for the system and the building in which it is housed. Lightning protection is necessary if the installation is in a locality in which electrical storms are common, particularly if primary power is supplied by overhead lines. If other devices are tied to the same earth ground which serves the computer system, a ground disconnect should be provided for the computer system.

SECTION II

EQUIPMENT DATA

2-1. INTRODUCTION.

2-2. This section contains specific data on the equipment that comprises the HP 2000A Time-Shared BASIC System.

2-3. DATA SHEETS.

2-4. The following sheets contain data on each item of equipment in the system. This data is to be used to prepare a site for the system. Each data sheet contains a photograph of the instrument, an outline drawing of the instrument including overall dimensions, and a table of specifications listing all data that is normally required for site preparation. Table 2-21 contains a listing of accessory items for the system. Most of these accessories are installed in the computer mainframe or the I/O and memory extender chassis. Weight, current drain, and heat dissipation figures for this apparatus are included in the figures for the related equipment. The following list contains the minimum hardware configuration for the system:

- a. HP 2116B Computer with Option 05, 16,384-Word Memory
- b. Direct Memory Access, Accessory No. 12578A
- c. Extended Arithmetic Unit, Accessory No. 12579A
- d. Power Fail Interrupt/Auto Restart, Accessory No. 12588A
- e. Memory Parity Check, Accessory No. 12591A
- f. Time Base Generator, Accessory No. 12539A
- g. 12584A-01 Teleprinter Multiplexer
- h. High Speed Tape Reader, consisting of:
 - HP 2737A High Speed Tape Reader (300 char/sec) with
 - HP 12532A High Speed Punched Tape Input Interface Kit
- i. Teleprinter Input/Output, consisting of:
 - HP 2754B Heavy-Duty Teleprinter (modified Teletype ASR-35)
 - with HP 12531B Teleprinter Input/Output Interface Kit
- j. Disc Memory consisting of:
 - HP 2770A-01 Disc Memory (368,640 words non-expandable)
 - HP 2772A Disc Memory Power Supply
 - HP 12606A Disc Memory Interface Kit
- k. 2160A Power Supply Extender
- l. 2992Z Two-Bay Cabinet
- m. System Integration and Accessories

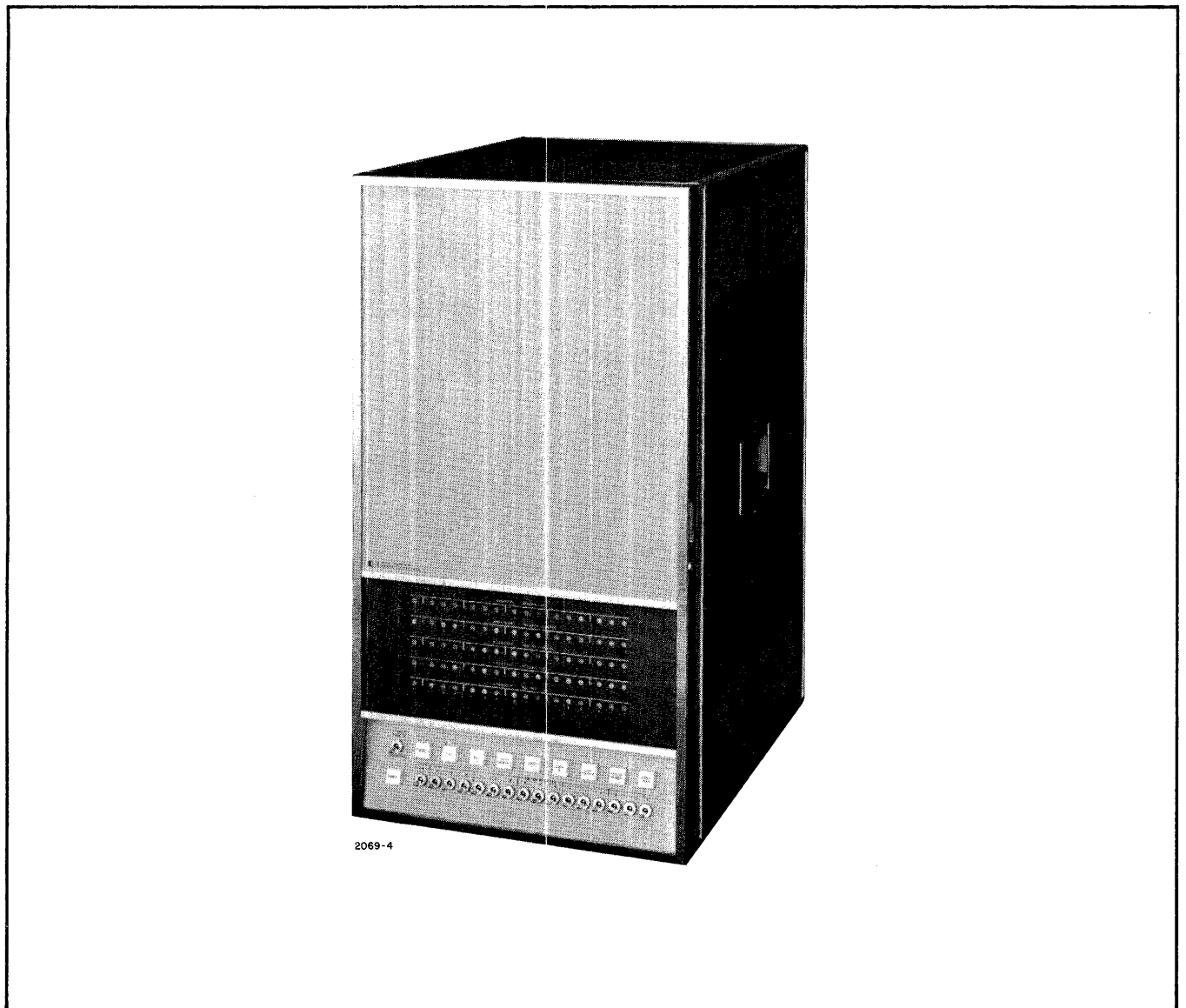
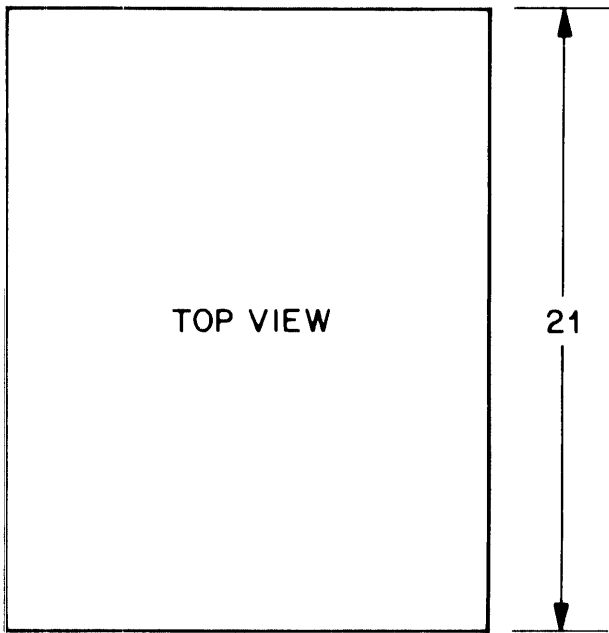

Figure 2-1. HP 2116B Computer

Table 2-1. HP 2116B Computer Specifications

DESCRIPTION:	Central processor unit with 16,384-word memory
WEIGHT:	240 pounds
CURRENT DRAIN:	10 amps at 115 volts ac, 5 amps at 230 volts ac
HEAT DISSIPATION:	5890 BTU/hour



NOTES:

- 1. ALL DIMENSIONS ARE IN INCHES.
- 2. RACK MOUNTING KIT NO. 5060-6236 INCREASES THE WIDTH OF THE INSTRUMENT TO 19 INCHES.

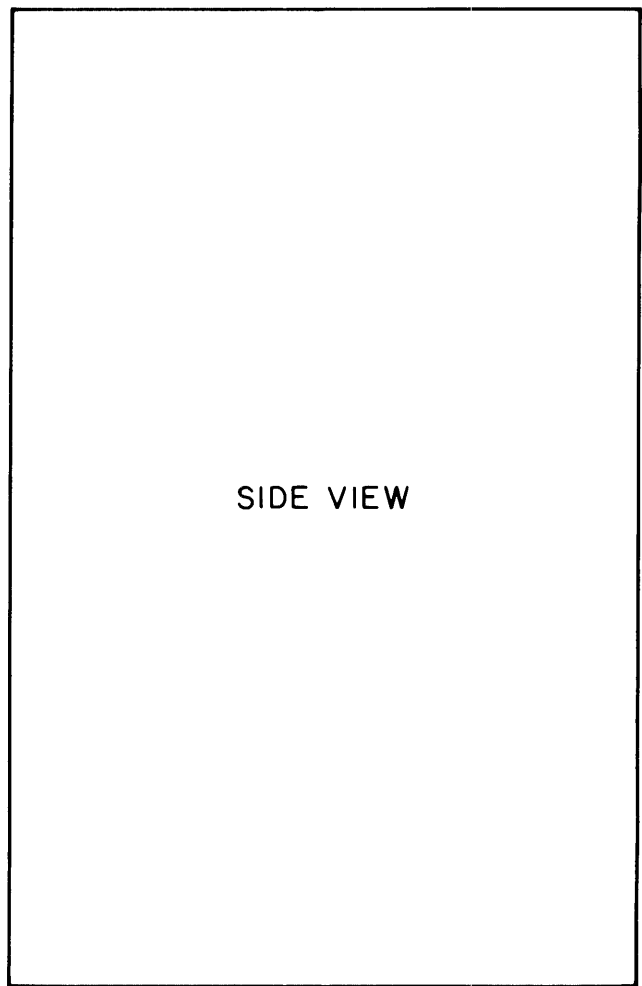
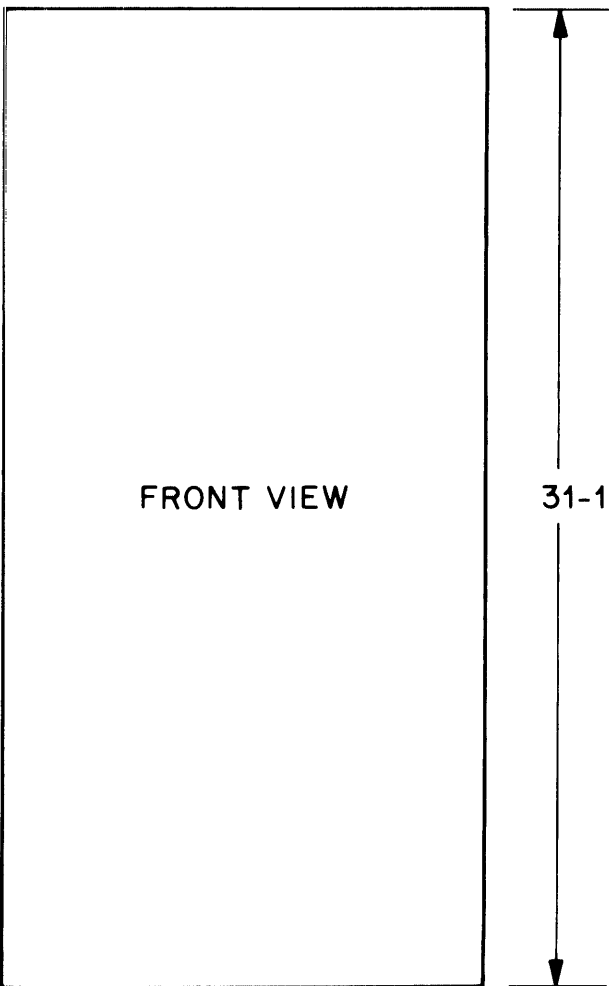
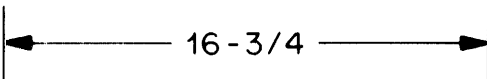
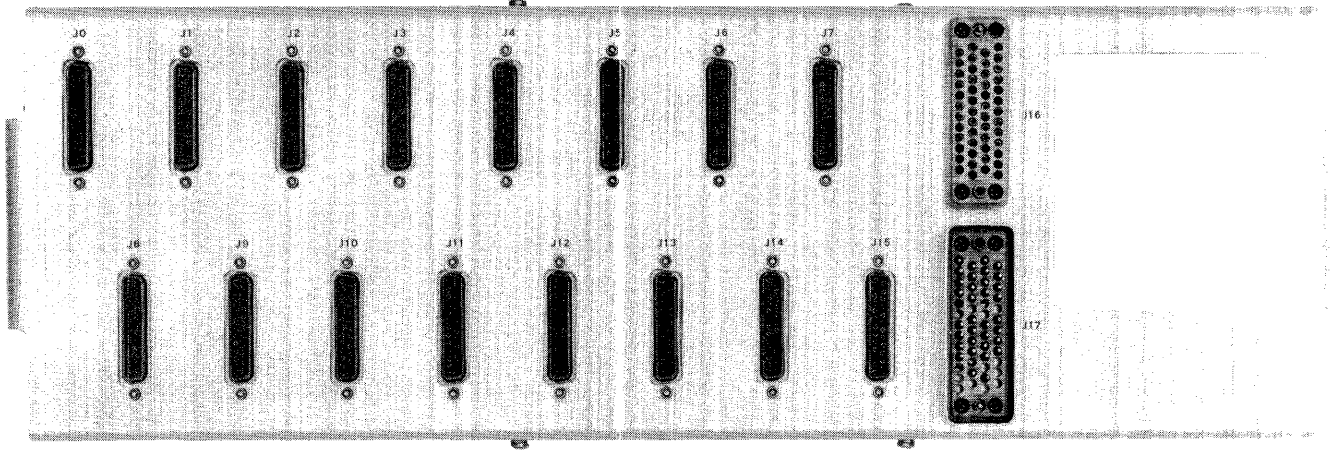

Figure 2-2. HP 2116B Computer Outline Drawing



2069-11

Figure 2-3. HP 12584A Teleprinter Multiplexor

Table 2-2. HP 12584A Teleprinter Multiplexor Specifications

DESCRIPTION:	Interfaces teleprinters or data sets to the computer
WEIGHT:	5 pounds
CURRENT DRAIN:	Included in drain for HP 2116B Computer
HEAT DISSIPATION:	Negligible

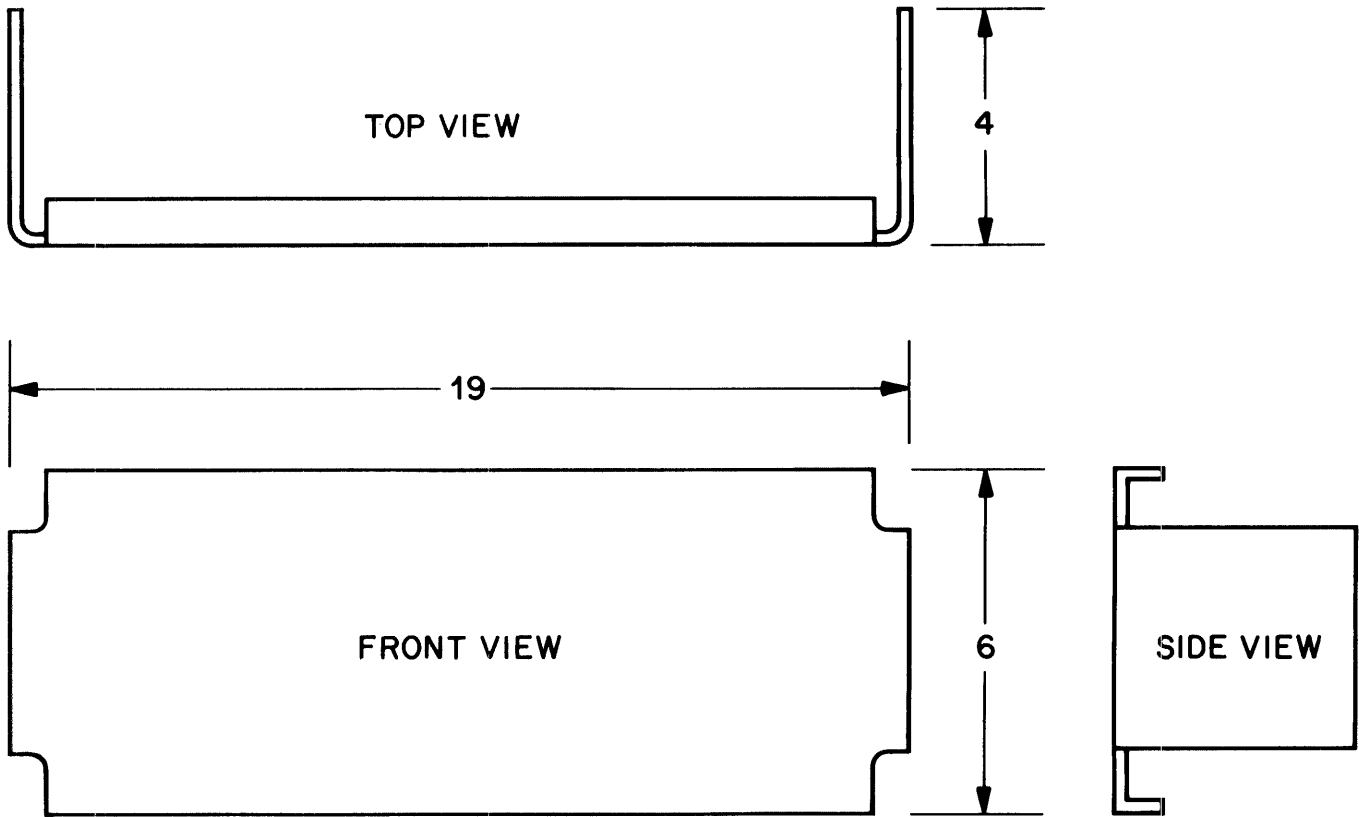

2069-22

NOTE: ALL DIMENSIONS ARE IN INCHES.

Figure 2-4. HP 12584A Teleprinter Multiplexor Outline Drawing

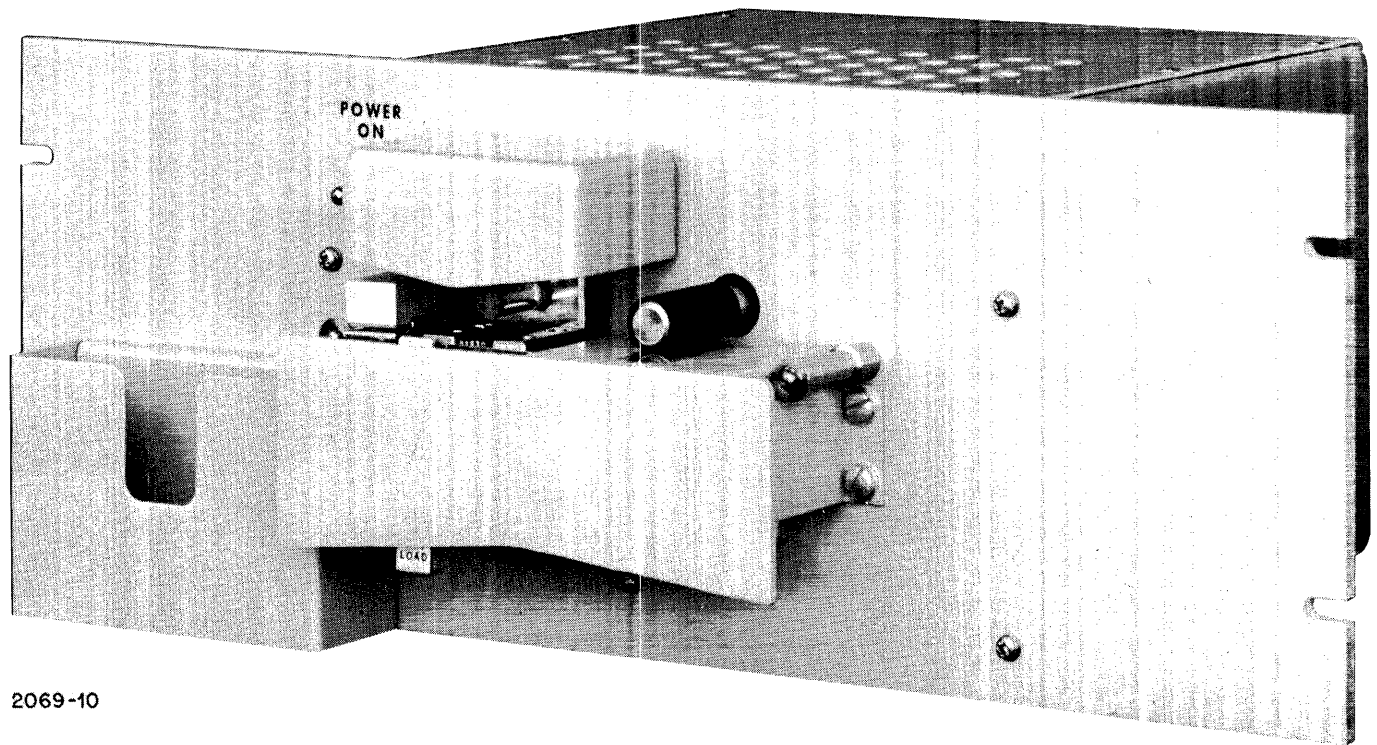

2069-10

Figure 2-5. HP 2737A Tape Reader .

Table 2-3. HP 2737A Tape Reader Specifications

DESCRIPTION:	Photoelectrically detects coded data characters on punched tape
WEIGHT:	15 pounds
CURRENT DRAIN:	1.3 amps at 115 volts ac
HEAT DISSIPATION:	510 BTU/hour
SIGNAL CABLE LENGTH:	10 feet

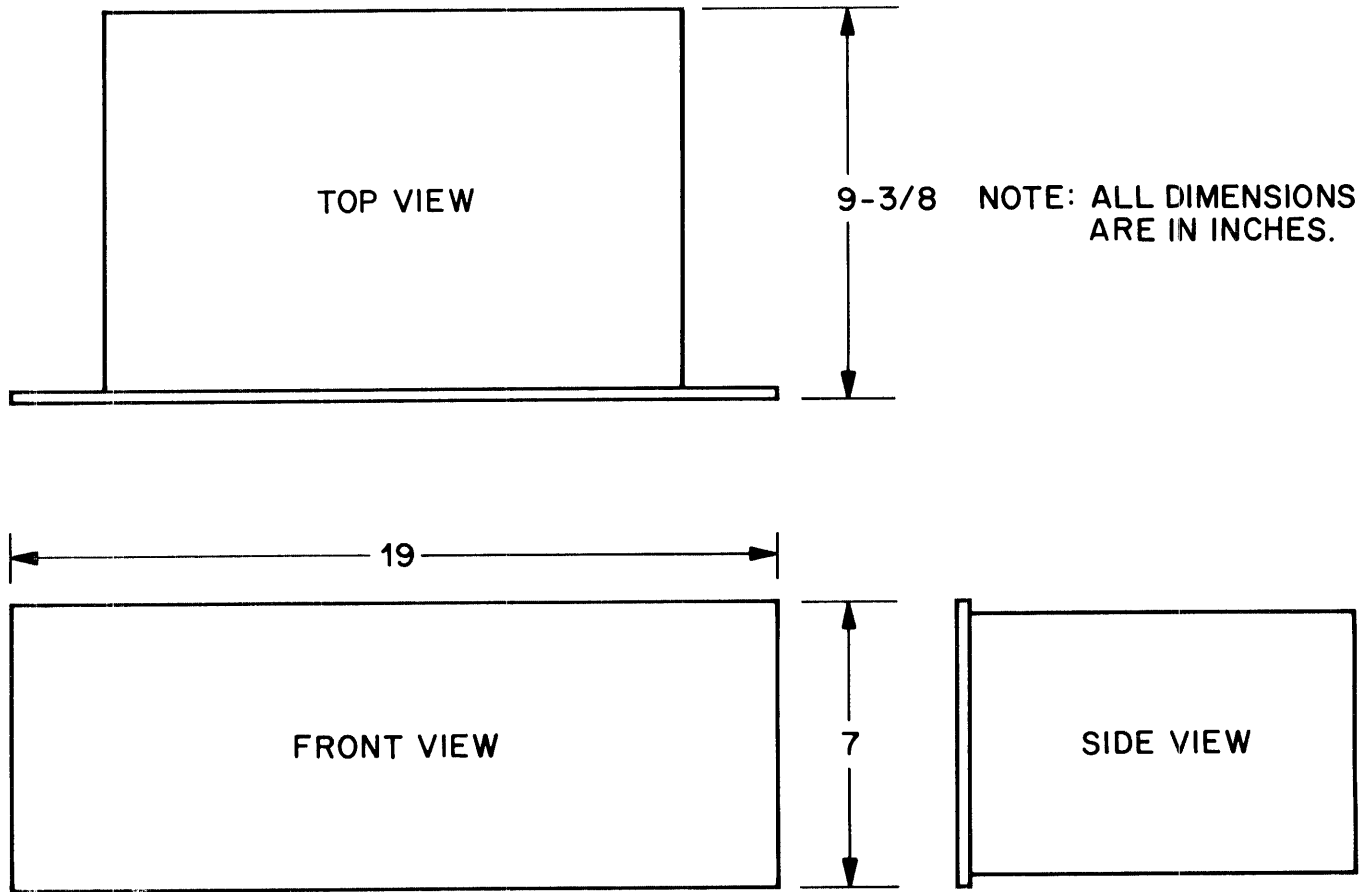

2069-23

Figure 2-6. HP 2737A Tape Reader Outline Drawing

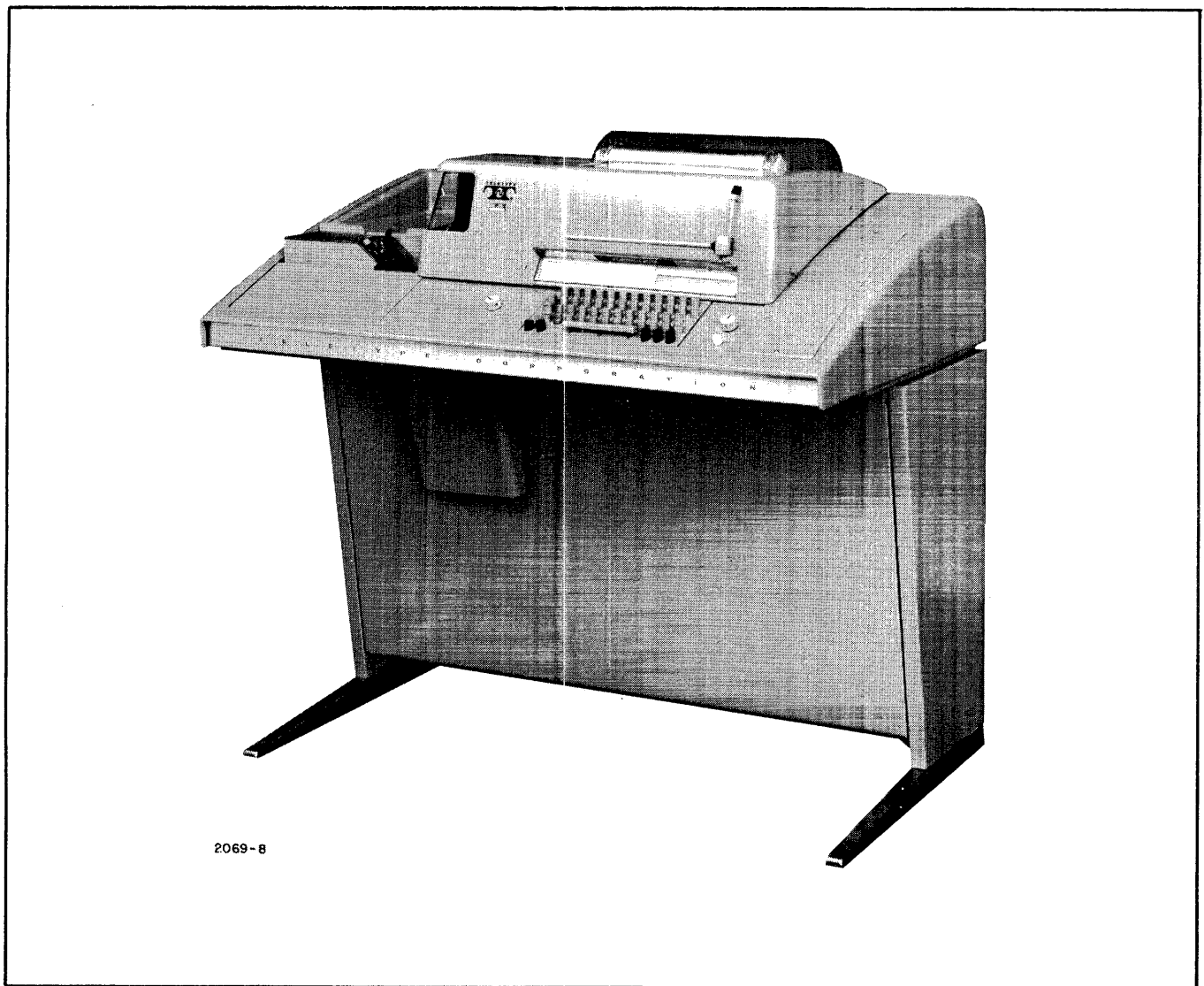
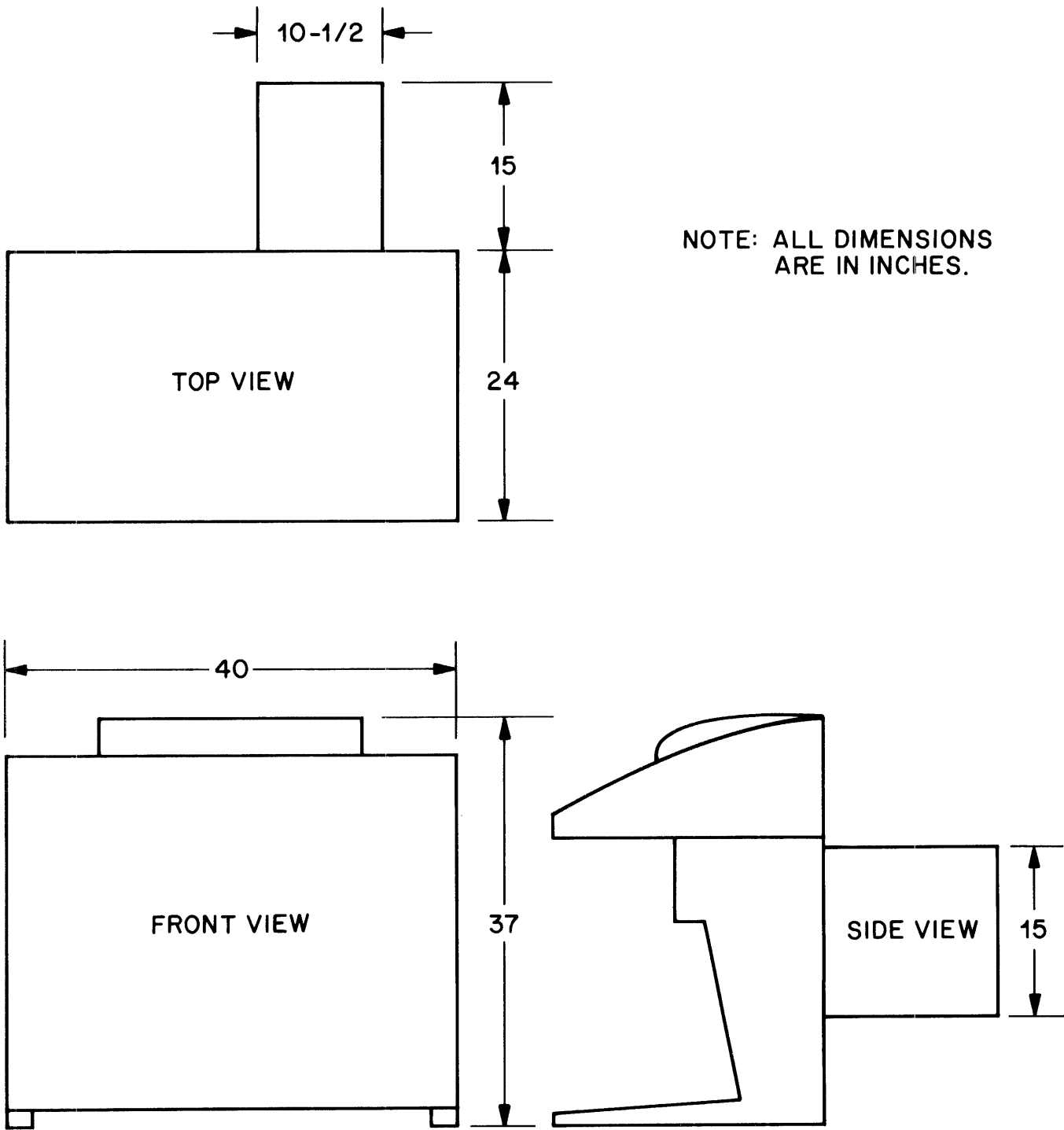

Figure 2-7. HP 2754B Teleprinter

Table 2-4. HP 2754B Teleprinter Specifications

DESCRIPTION:	Provides direct input/output capability with the computer
WEIGHT:	225 pounds
CURRENT DRAIN:	4 amps at 115 volts ac
HEAT DISSIPATION:	1500 BTU/hour
SIGNAL CABLE LENGTH:	20 feet



2069-24

Figure 2-8. HP 2754B Teleprinter Outline Drawing

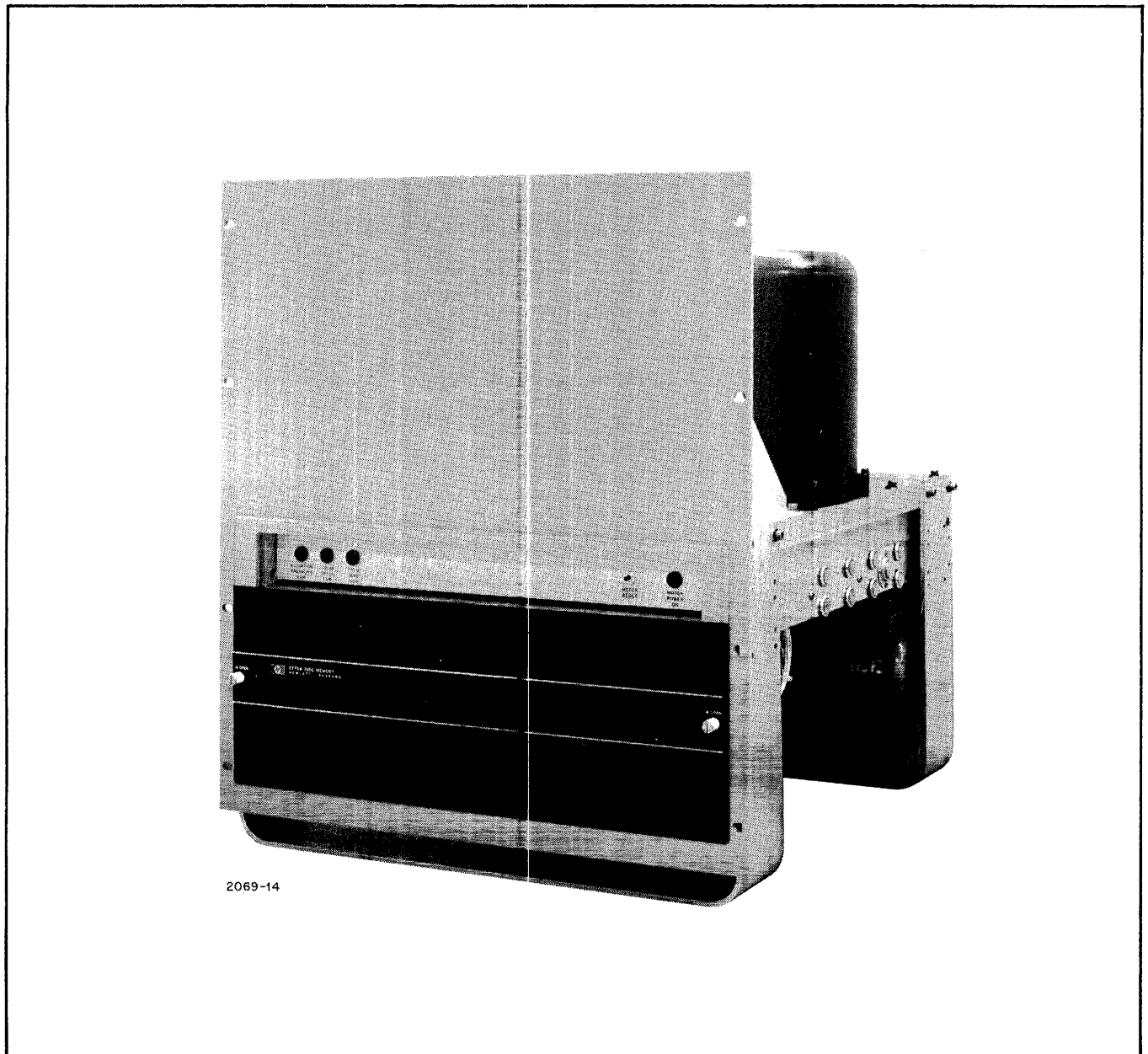
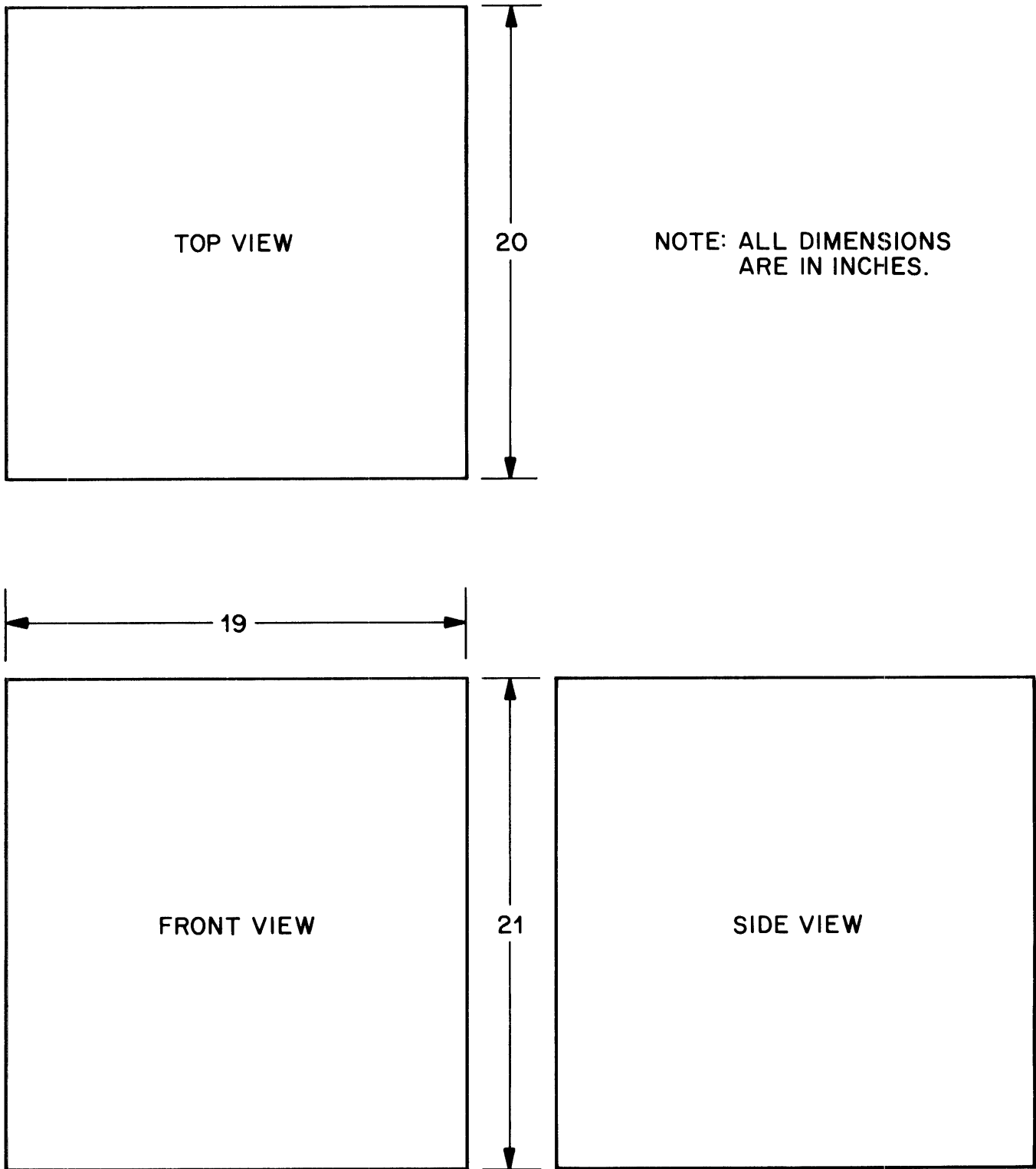

Figure 2-9. HP 2770A Disc Memory

Table 2-5. HP 2770A Disc Memory Specifications

DESCRIPTION:	Bulk high-speed memory unit with a non-expandable capacity of 368,640 words
WEIGHT:	165 pounds
CURRENT DRAIN:	1.8 amps starting, 0.5 amp running at 115 volts ac
HEAT DISSIPATION:	200 BTU/hour
SIGNAL CABLE LENGTH:	10 feet



2069-35

Figure 2-10. HP 2770A Disc Memory Outline Drawing

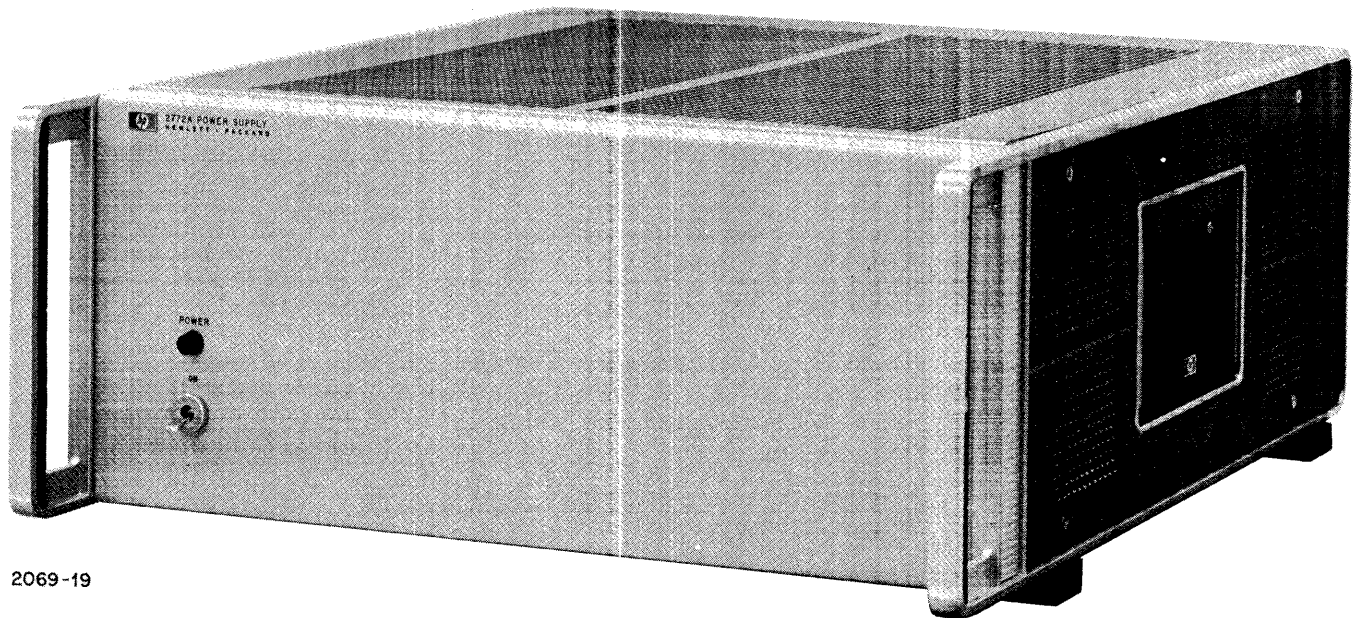

2069-19

Figure 2-11. HP 2772A Power Supply

Table 2-6. HP 2772A Power Supply Specifications

DESCRIPTION:	Provides required power for the disc memory
WEIGHT:	41 pounds
CURRENT DRAIN:	1.4 amps at 115 volts ac
HEAT DISSIPATION:	500 BTU/hour

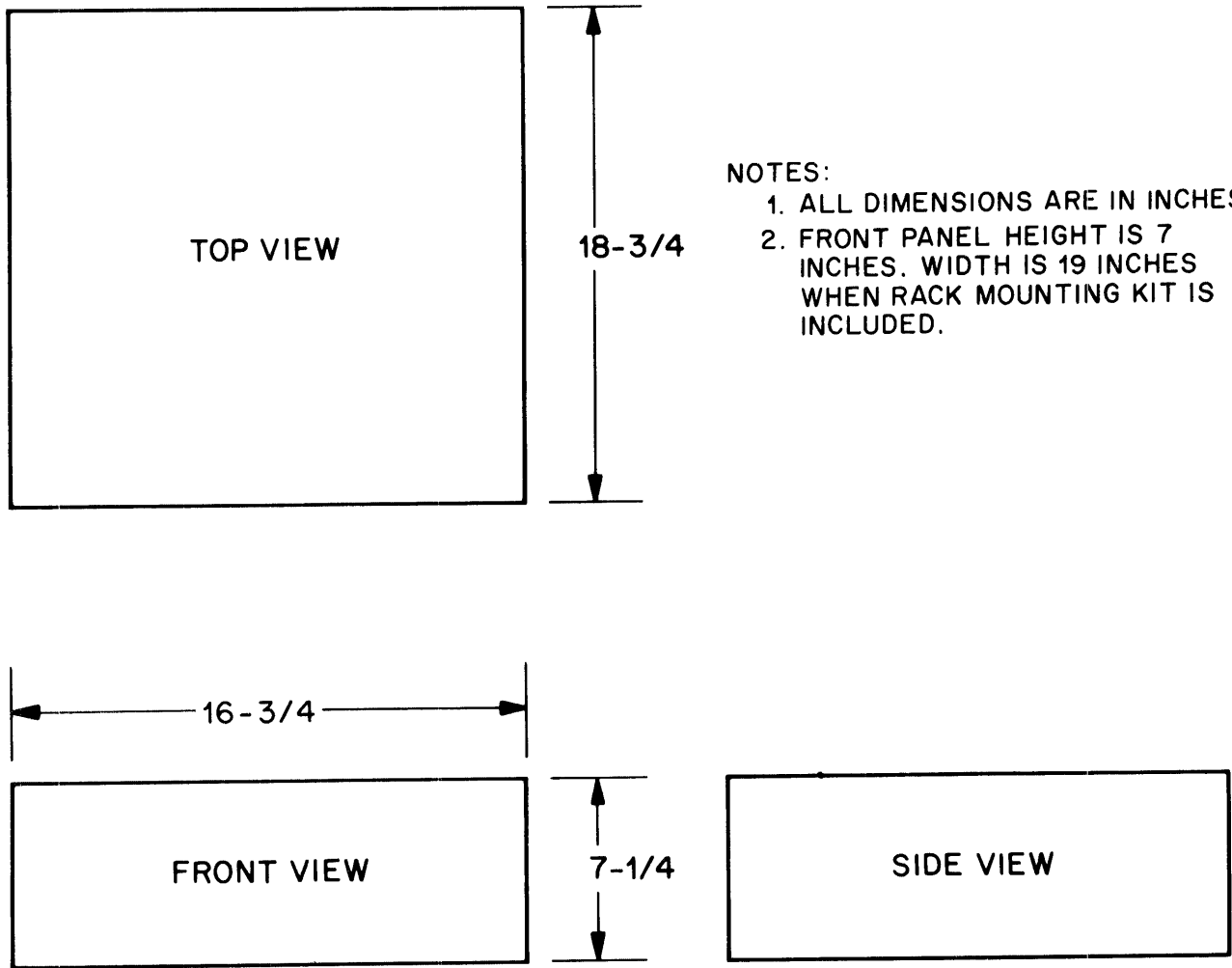

2069-25

Figure 2-12. HP 2772A Power Supply Outline Drawing

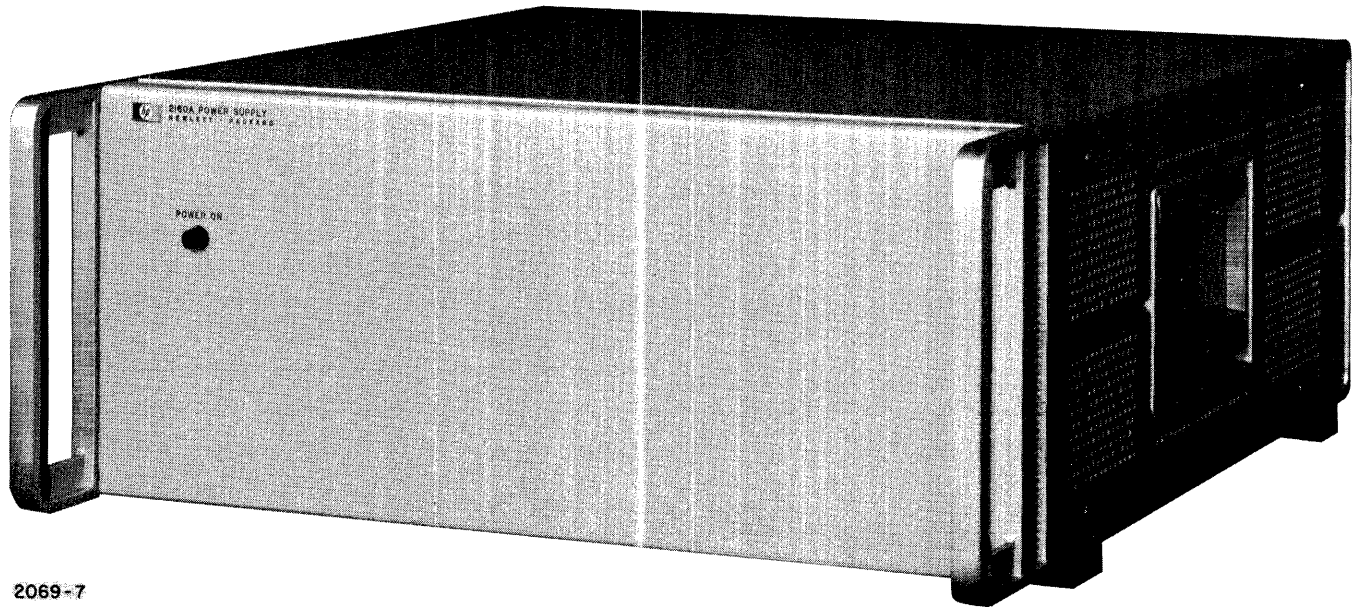

2069-7

Figure 2-13. HP 2160A Power supply

Table 2-7. HP 2160A Power Supply Specifications

DESCRIPTION:	Provides additional computer power
WEIGHT:	43 pounds
CURRENT DRAIN:	3 amps at 115 volts ac
HEAT DISSIPATION:	1180 BTU/hour

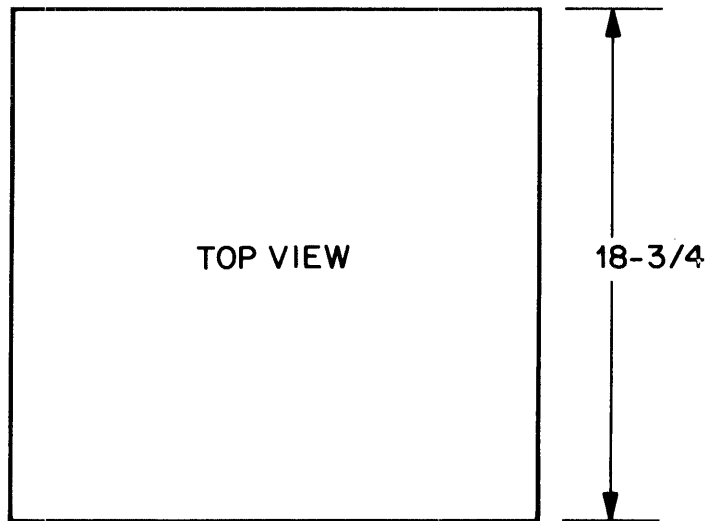

- NOTES:
1. ALL DIMENSIONS ARE IN INCHES.
 2. FRONT PANEL HEIGHT IS 7 INCHES. WIDTH IS 19 INCHES WHEN RACK MOUNTING KIT IS INCLUDED.

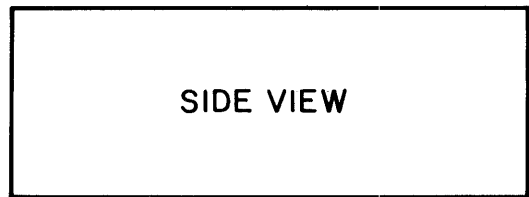
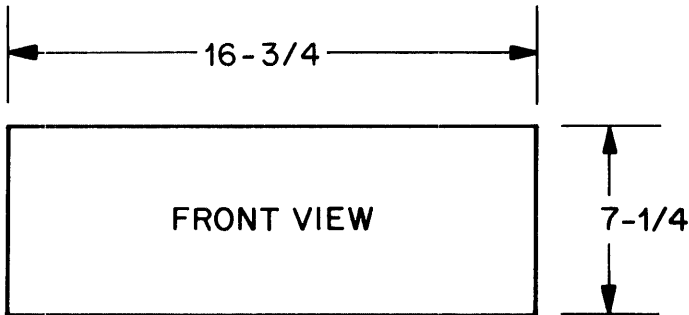

2069-25

Figure 2-14. HP 2160A Power Supply Outline Drawing

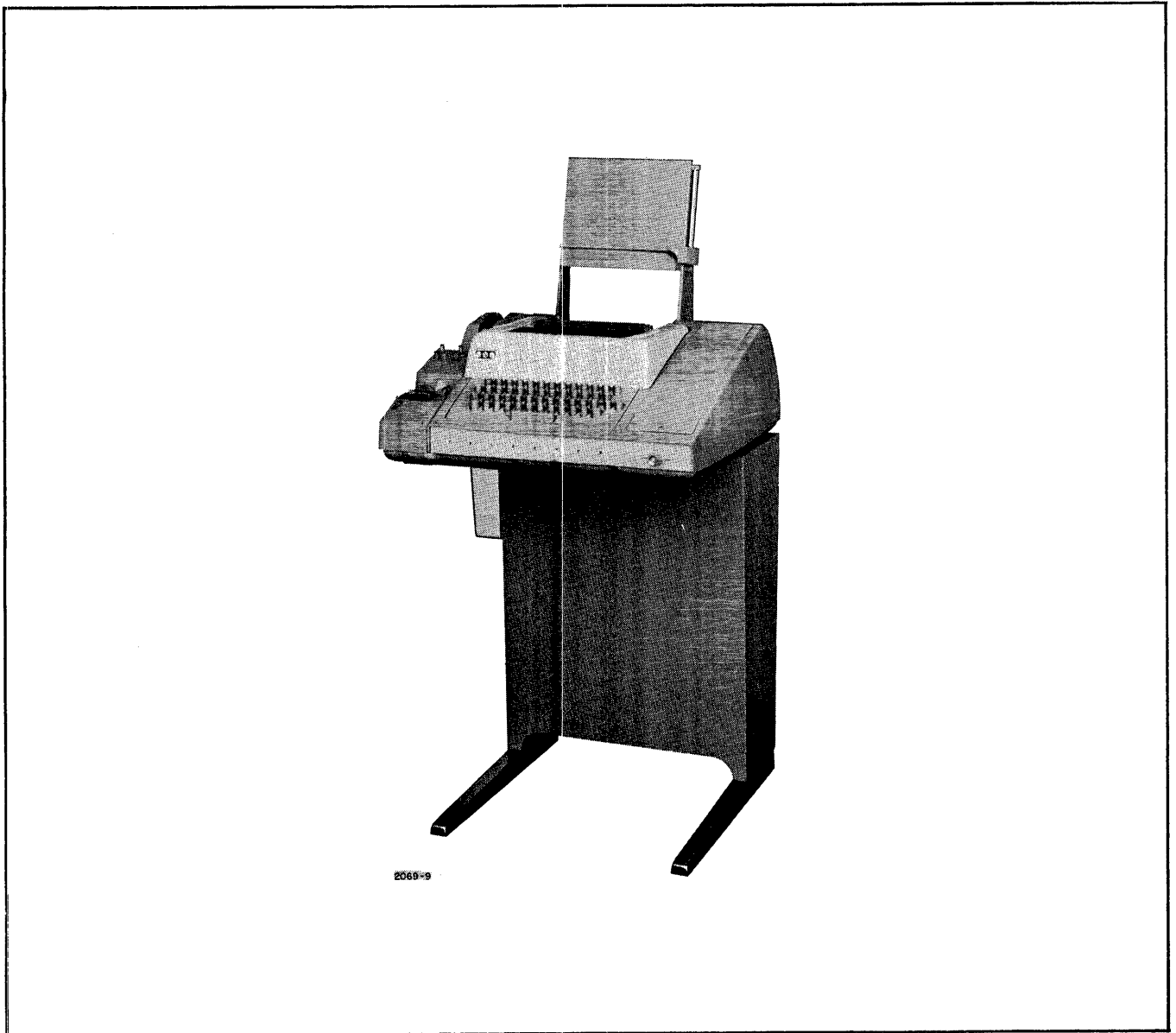
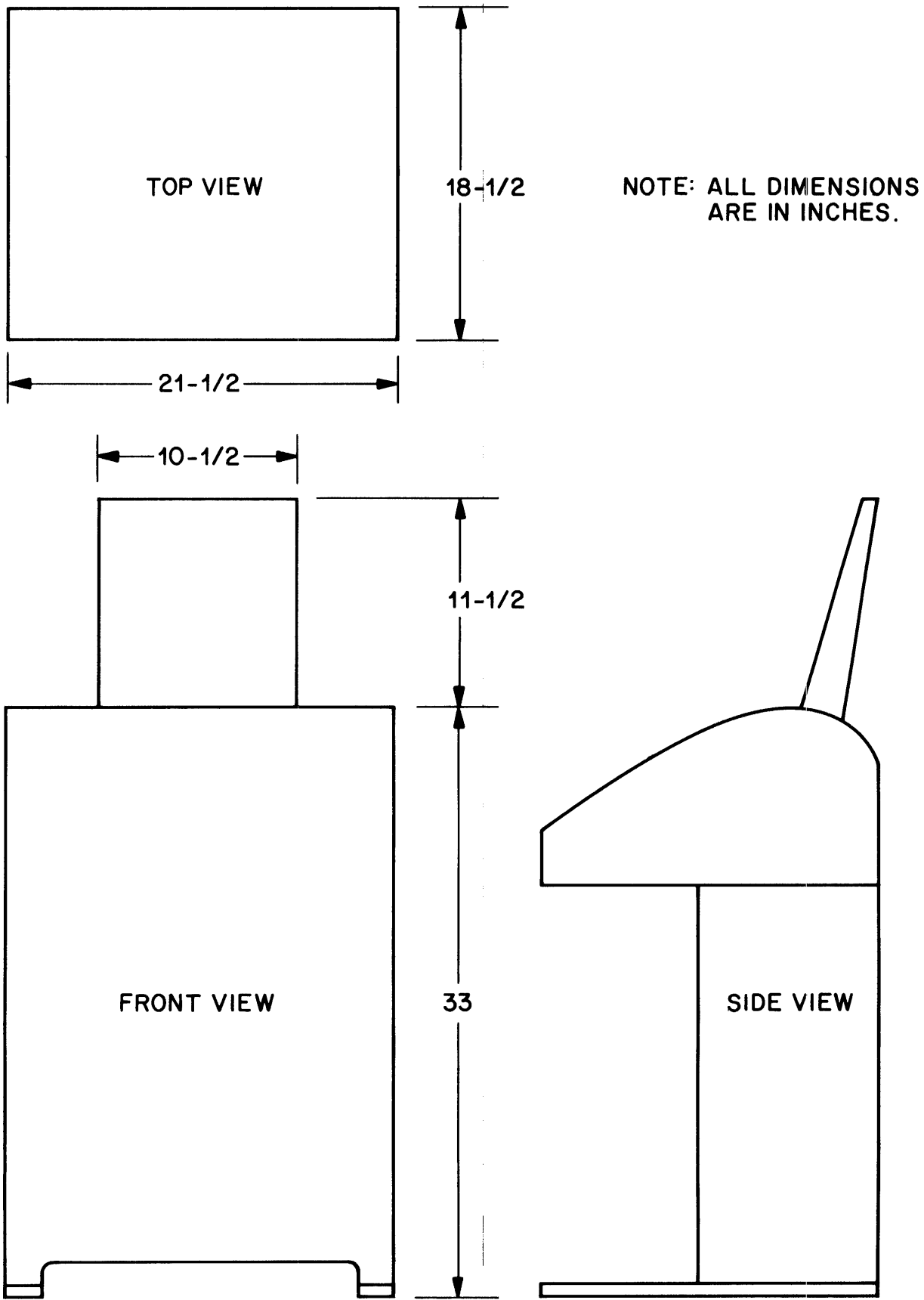

Figure 2-15. HP 2749A Teleprinter

Table 2-8. HP 2749A Teleprinter Specifications

DESCRIPTION:	Additional teleprinters for use with the system
WEIGHT:	95 pounds
CURRENT DRAIN:	2 amps at 115 volts ac
HEAT DISSIPATION:	775 BTU/hour
SIGNAL CABLE LENGTH:	10 feet



2069-26

Figure 2-16. HP 2749A Teleprinter Outline Drawing

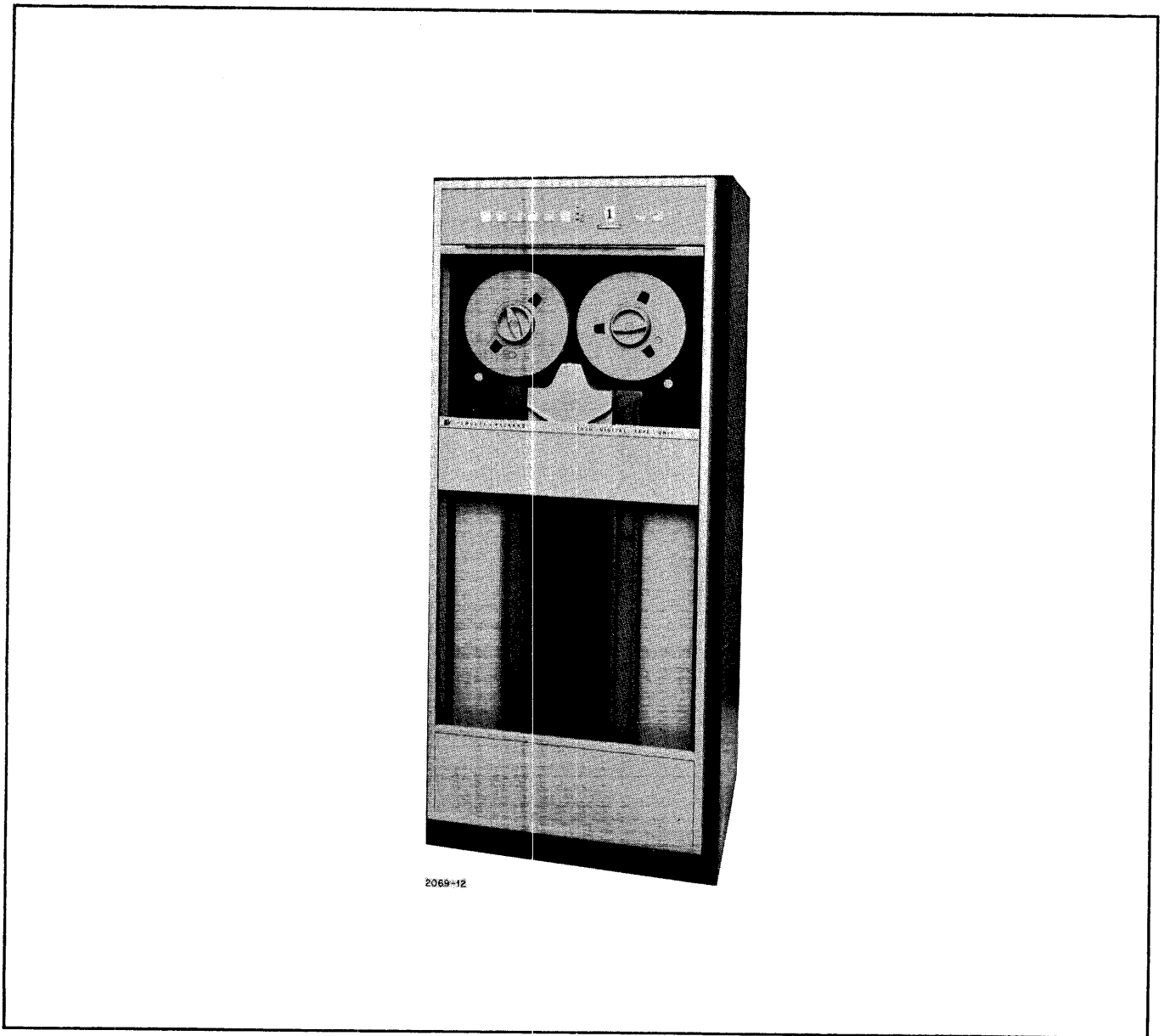
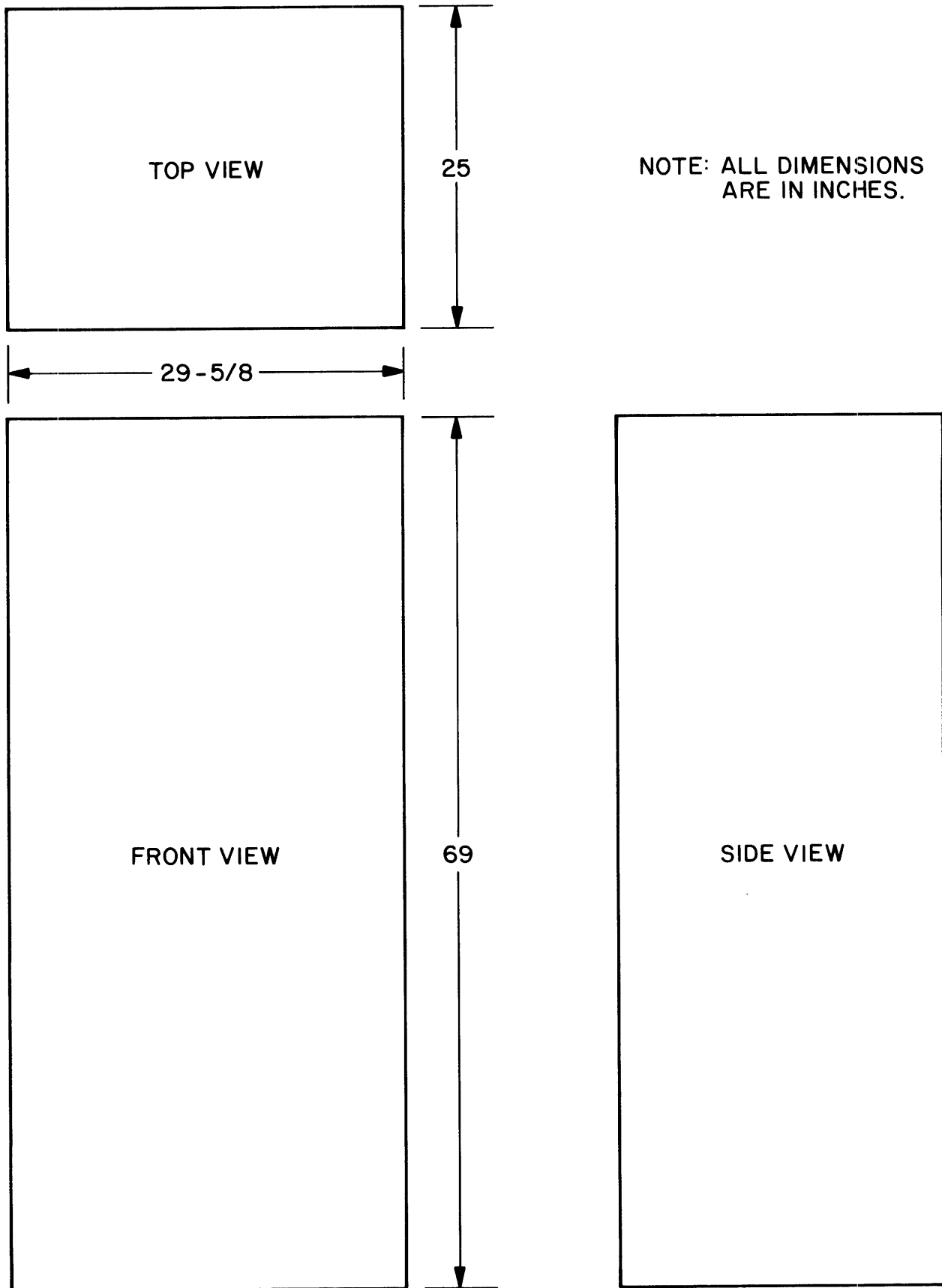

Figure 2-17. HP 3030G Digital Tape Unit

Table 2-9. HP 3030G Digital Tape Unit Specifications

DESCRIPTION:	Bulk magnetic tape memory unit. Read/write rate is 60,000 characters per second.
WEIGHT:	150 pounds
CURRENT DRAIN:	9 amps starting, 6.5 amps running at 115 volts ac
HEAT DISSIPATION:	2500 BTU/hour
SIGNAL CABLE LENGTH:	15 feet



2069-27

Figure 2-18. HP 3030G Digital Tape Unit Outline Drawing

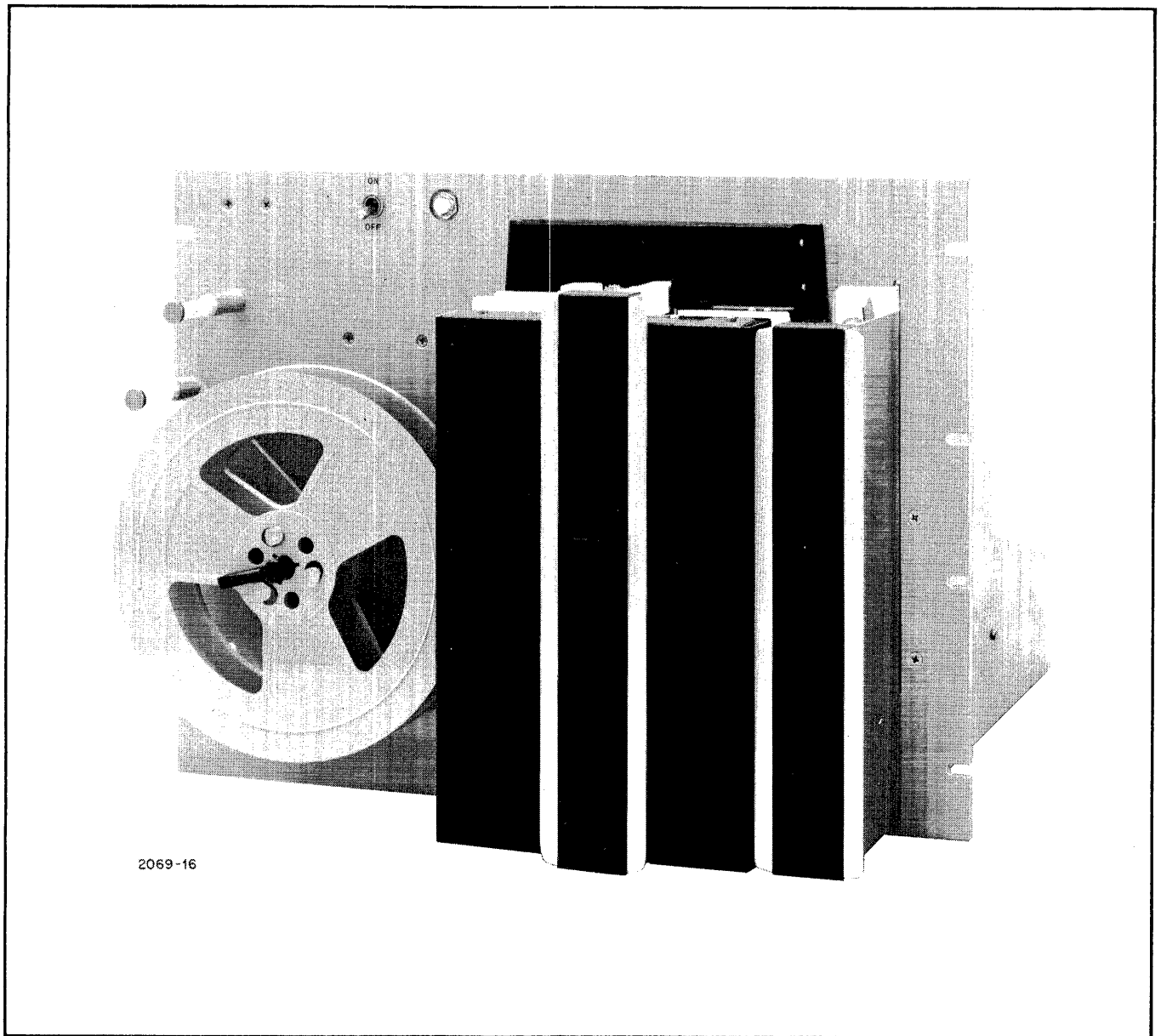
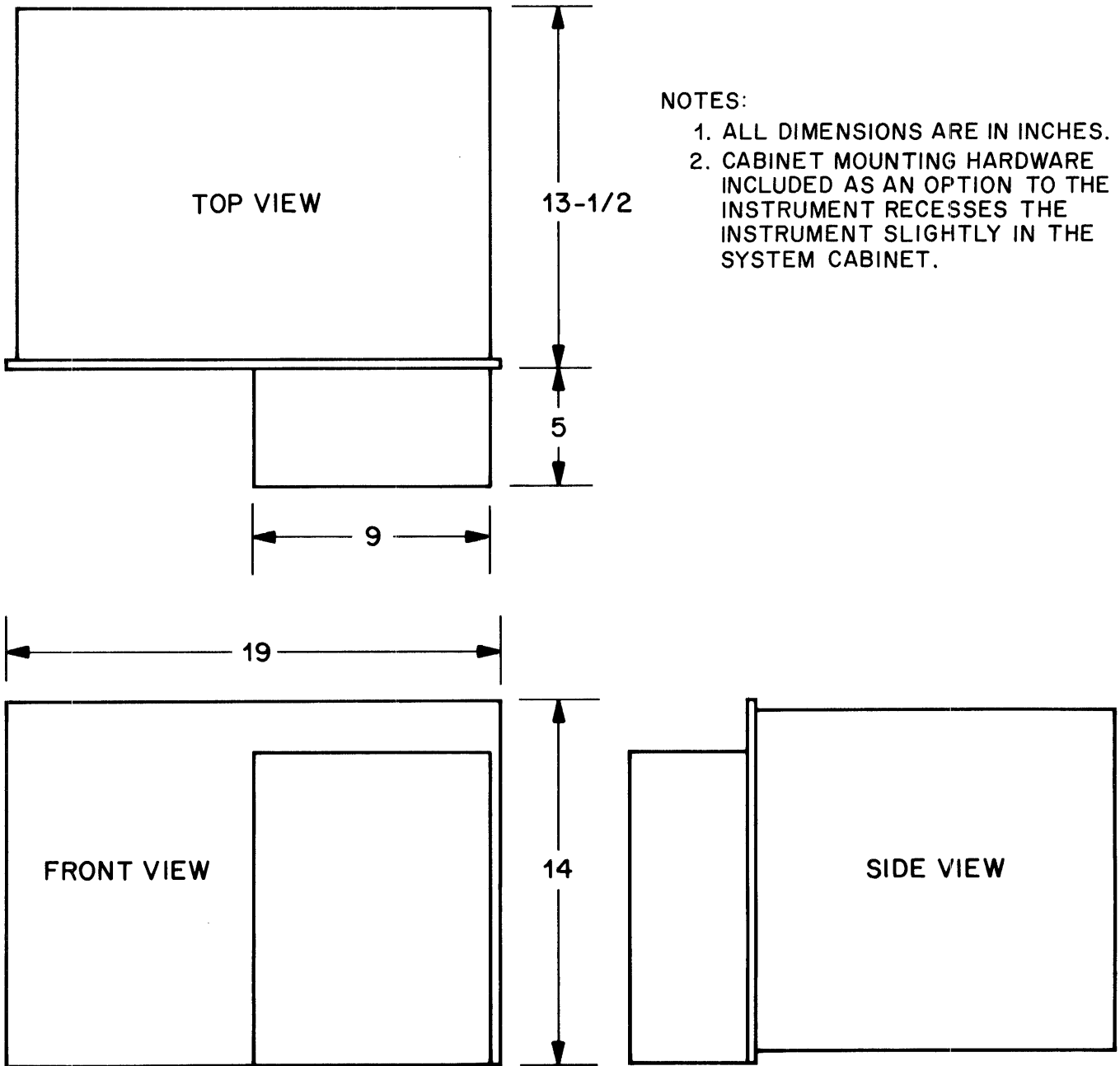

Figure 2-19. HP 2753A Tape Punch

Table 2-10. HP 2753A Tape Punch Specifications

DESCRIPTION:	Punches coded data characters in tape. Rate is 120 characters per second.
WEIGHT:	59 pounds
CURRENT DRAIN:	4 amps at 115 volts ac
HEAT DISSIPATION:	1500 BTU/hour
SIGNAL CABLE LENGTH:	15 feet



NOTES:

- 1. ALL DIMENSIONS ARE IN INCHES.
- 2. CABINET MOUNTING HARDWARE INCLUDED AS AN OPTION TO THE INSTRUMENT RECESSES THE INSTRUMENT SLIGHTLY IN THE SYSTEM CABINET.

2069-28

Figure 2-20. HP 2753A Tape Punch Outline Drawing

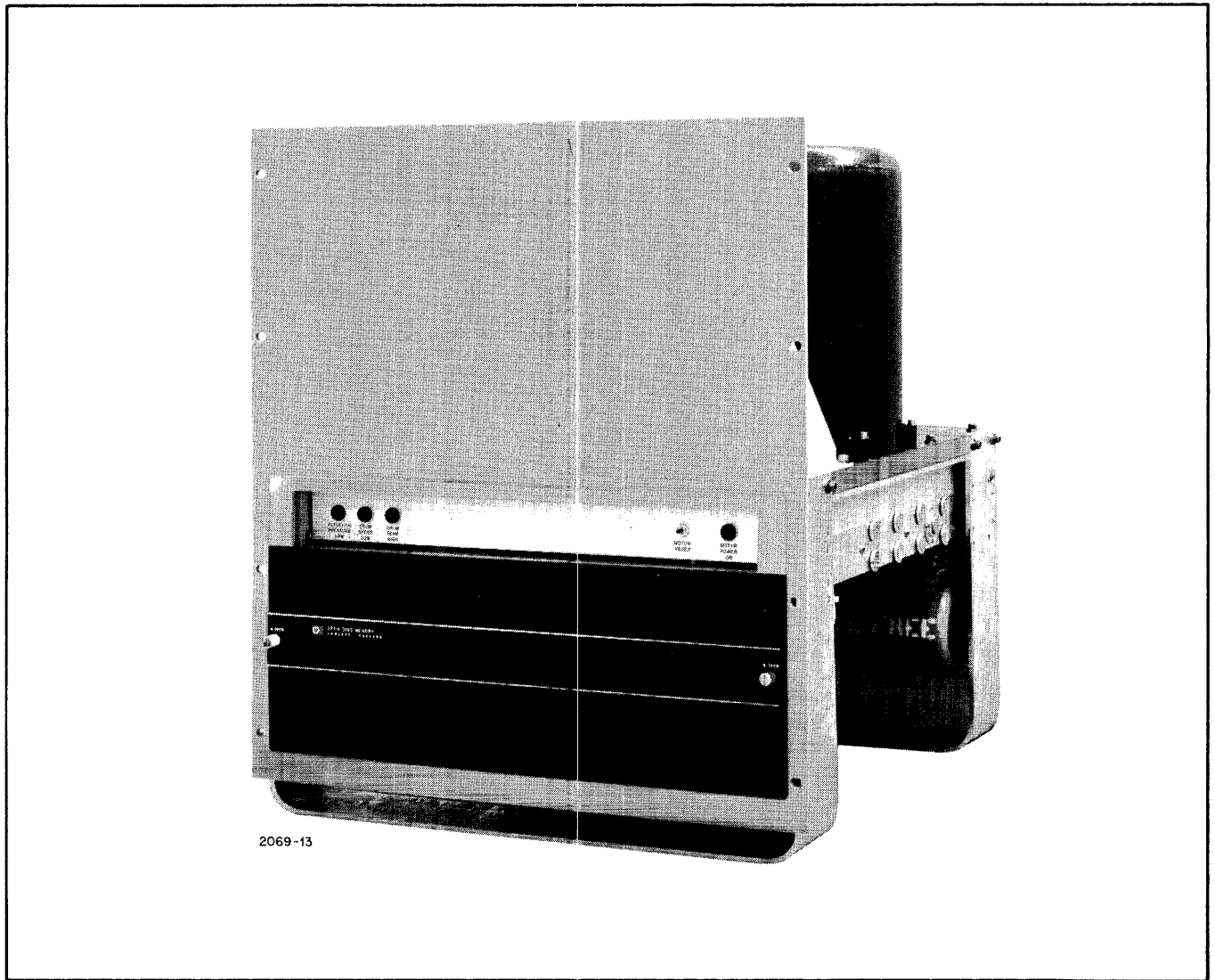
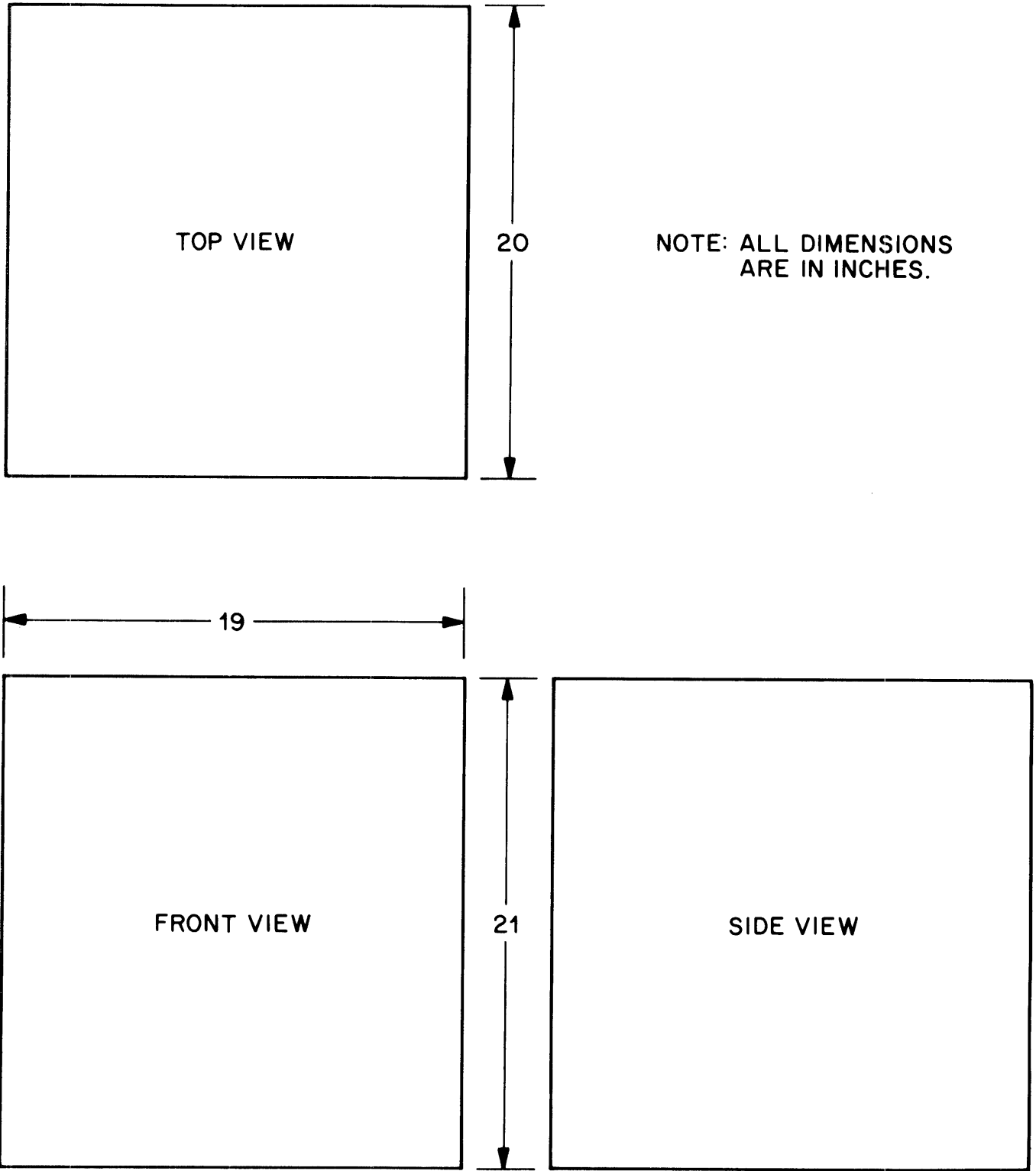

Figure 2-21. HP 2771A Disc Memory

Table 2-11. HP 2771A Disc Memory Specifications

DESCRIPTION:	Additional disc memory storage with a capacity of 368,640 words; expandable to 737,280 words.
WEIGHT:	185 pounds
CURRENT DRAIN:	2 amps starting, 0.6 amps running at 115 volts ac
HEAT DISSIPATION:	250 BTU/hour
SIGNAL CABLE LENGTH:	10 feet



2069-35

Figure 2-22. HP 2771A Disc Memory Outline Drawing

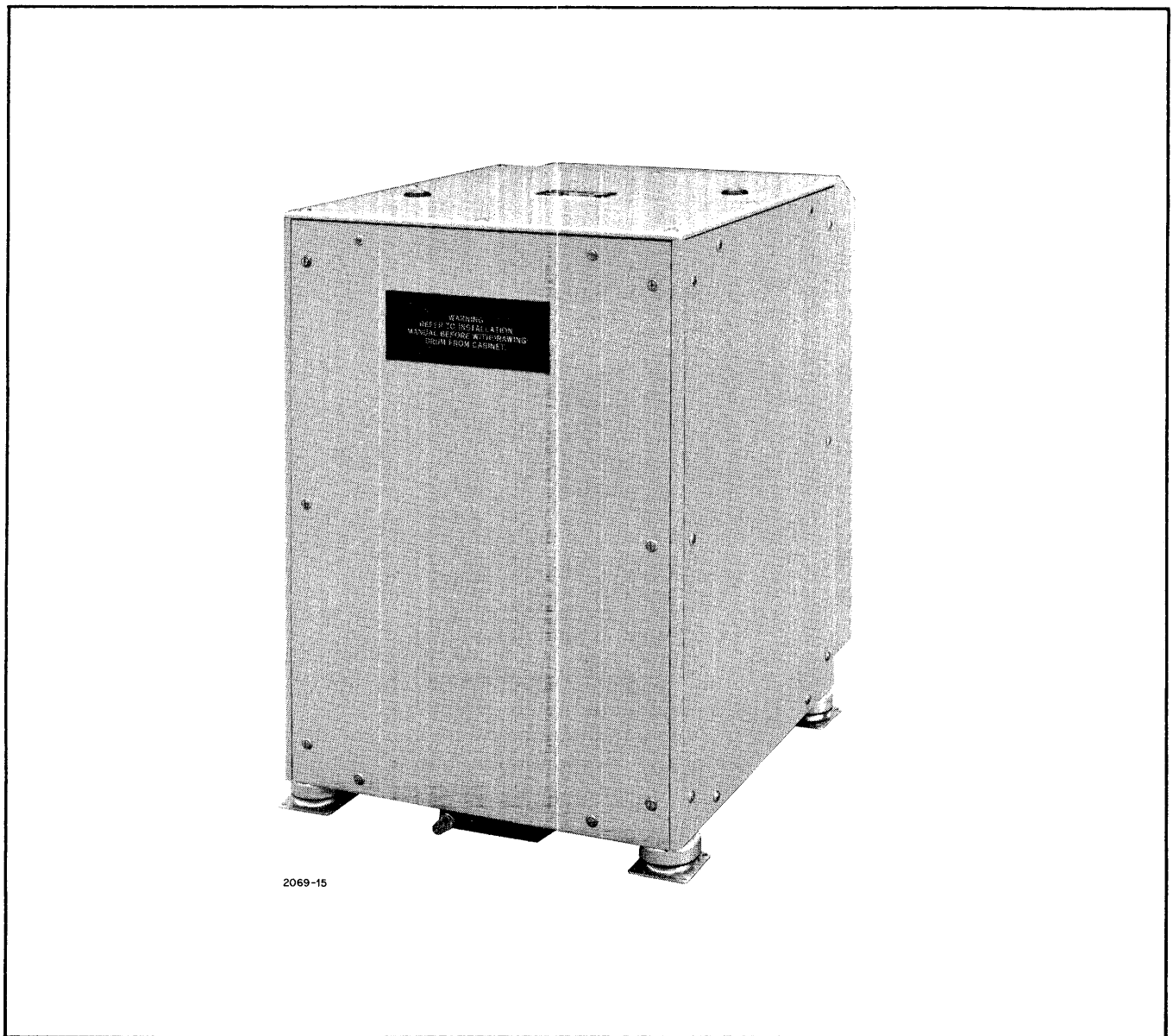
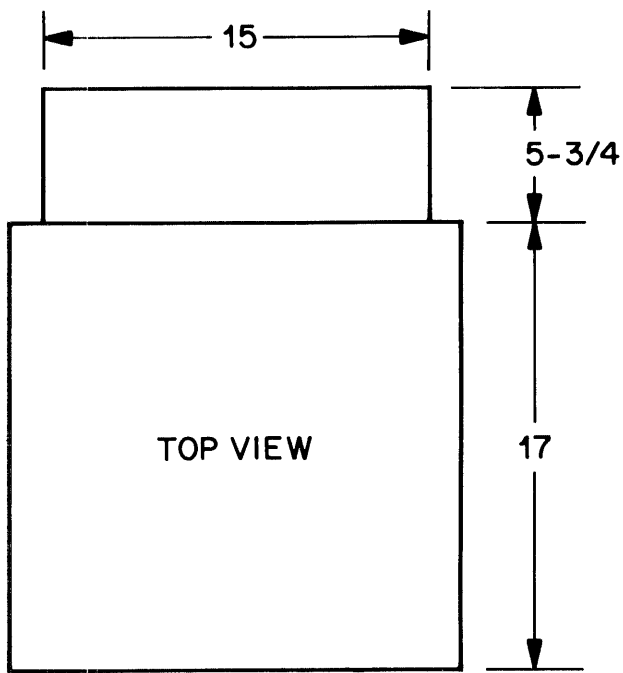

Figure 2-23. HP 2773A Drum Memory

Table 2-12. HP 2773A Drum Memory Specifications

DESCRIPTION:	Additional drum memory storage with a capacity of 786,432 words
WEIGHT:	185 pounds
CURRENT DRAIN:	Included with HP 2776A Power Supply current
HEAT DISSIPATION:	Included with HP 2776A Power Supply heat dissipation
SIGNAL CABLE LENGTH:	10 feet



NOTES:

- 1. ALL DIMENSIONS ARE IN INCHES.
- 2. WHEN INSTRUMENT IS MOUNTED IN CABINET, FRONT PANEL HEIGHT IS 40-1/4 INCHES.

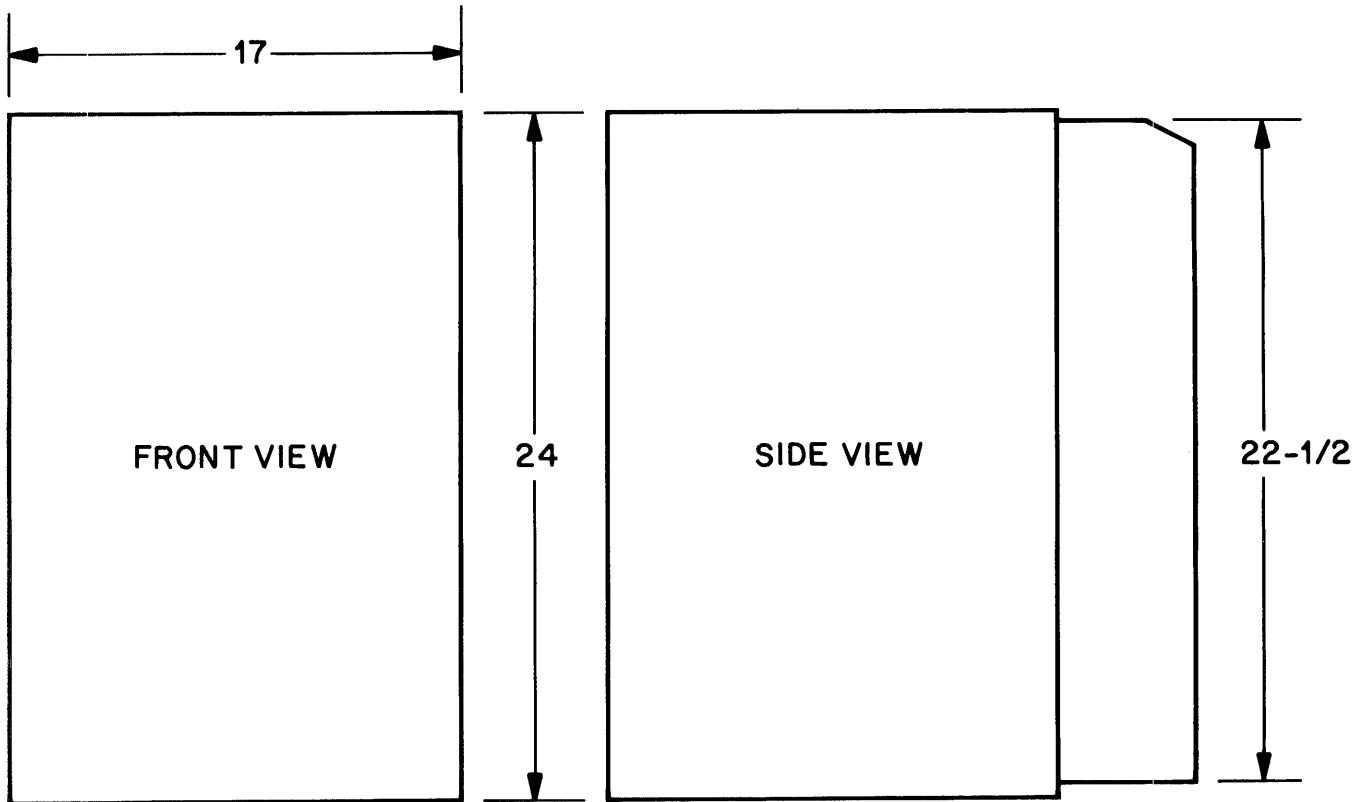

2069-29

Figure 2-24. HP 2773A Drum Memory Outline Drawing

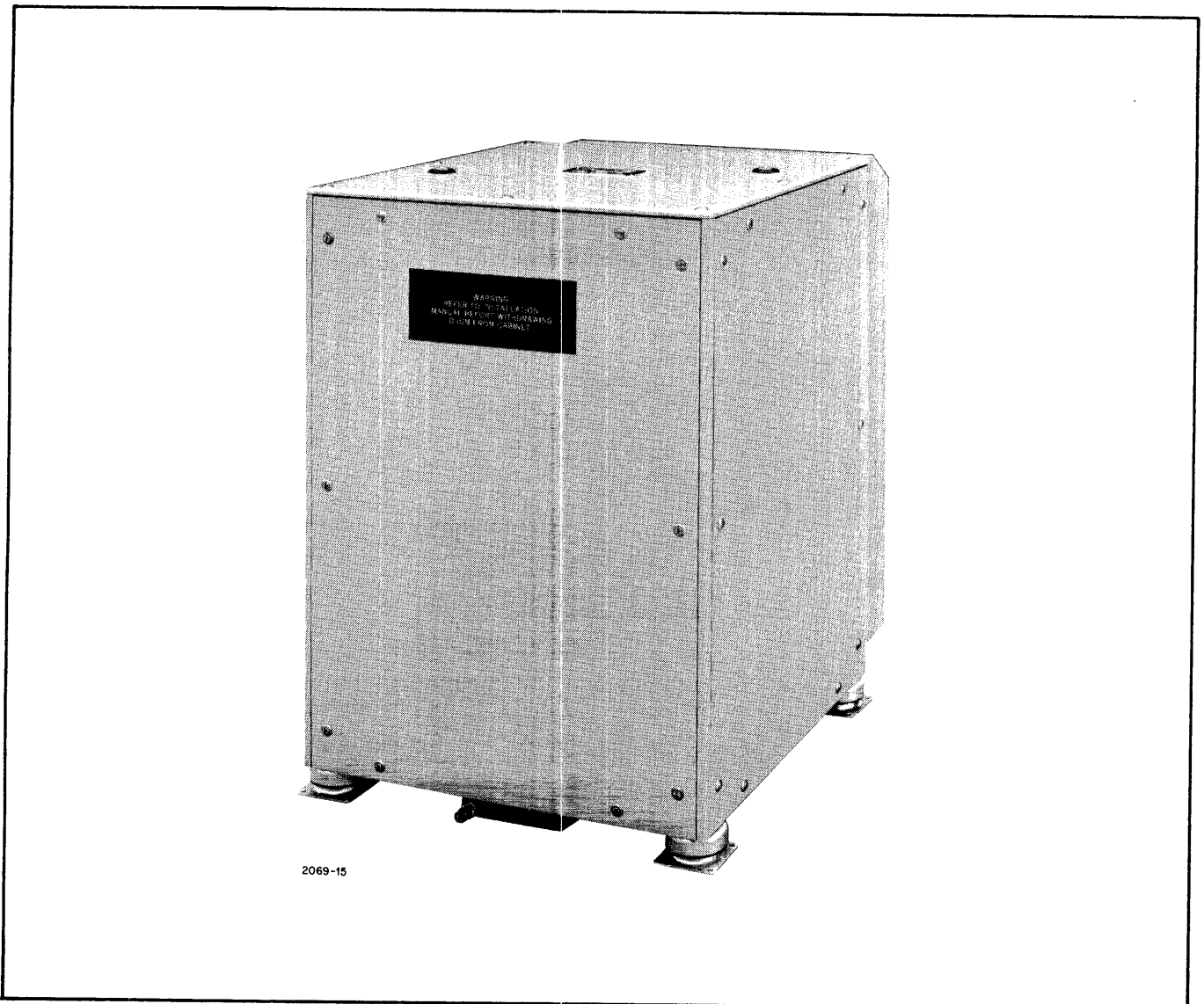
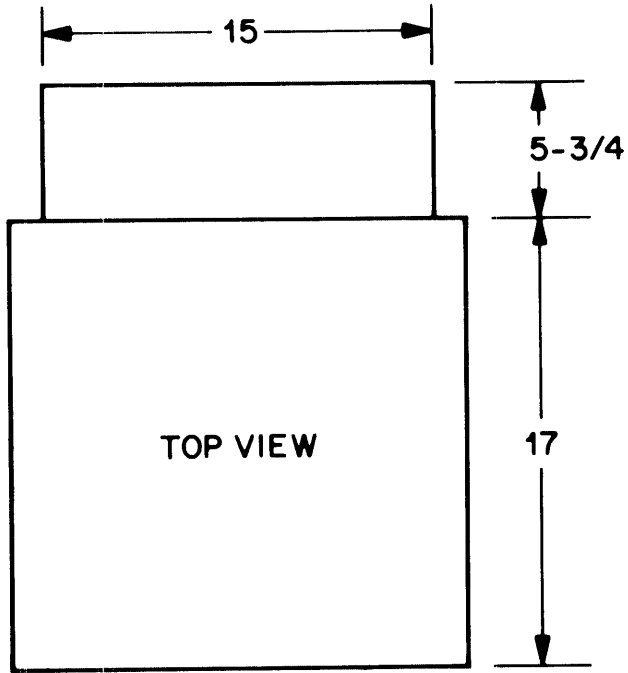

Figure 2-25. HP 2774A Drum Memory

Table 2-13. HP 2774A Drum Memory Specifications

DESCRIPTION:	Additional drum memory storage with a capacity of 393,216 words
WEIGHT:	185 pounds
CURRENT DRAIN:	Included with HP 2776A Power Supply current
HEAT DISSIPATION:	Included with HP 2776A Power Supply heat dissipation
SIGNAL CABLE LENGTH:	10 feet



NOTES:

- 1. ALL DIMENSIONS ARE IN INCHES.
- 2. WHEN INSTRUMENT IS MOUNTED IN CABINET, FRONT PANEL HEIGHT IS 40-1/4 INCHES.

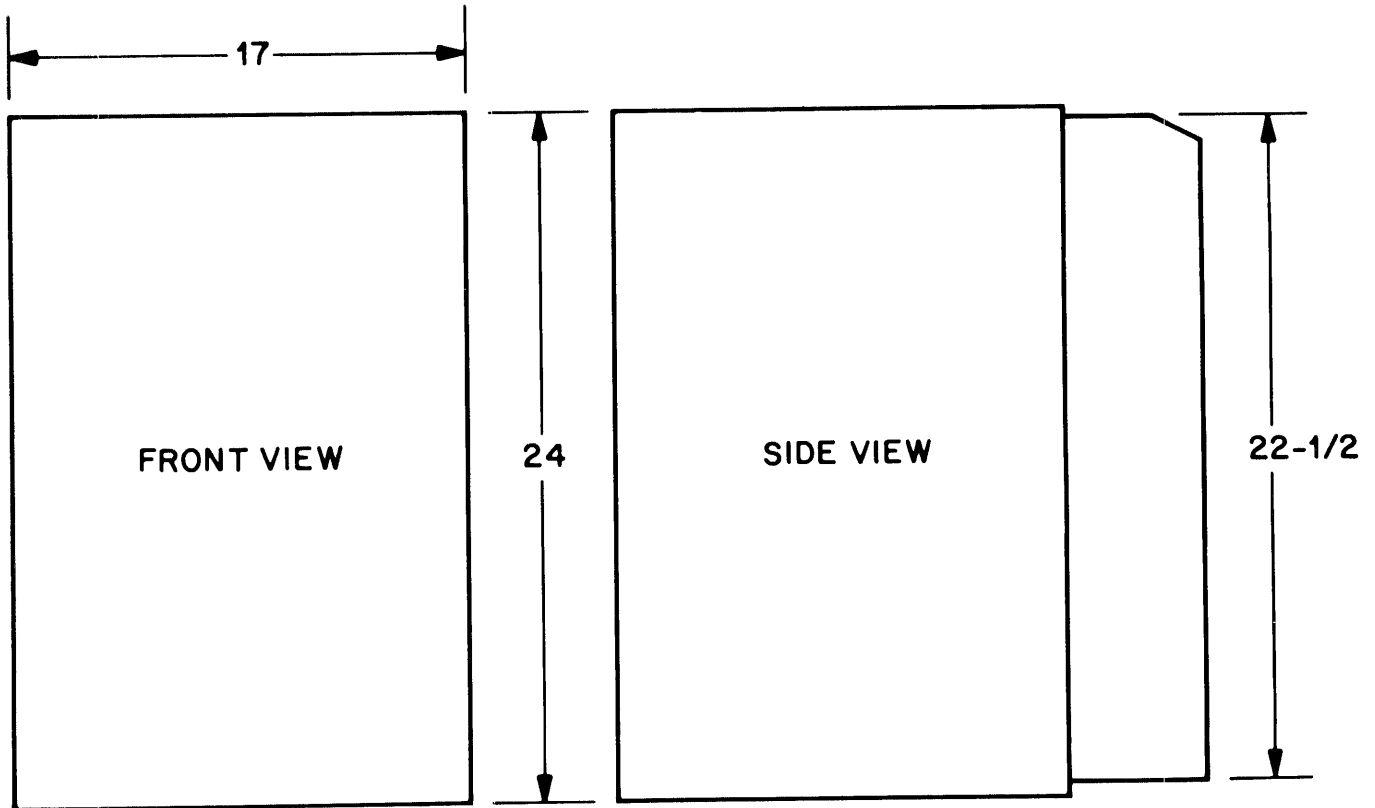

2069-29

Figure 2-26. HP 2774A Drum Memory Outline Drawing

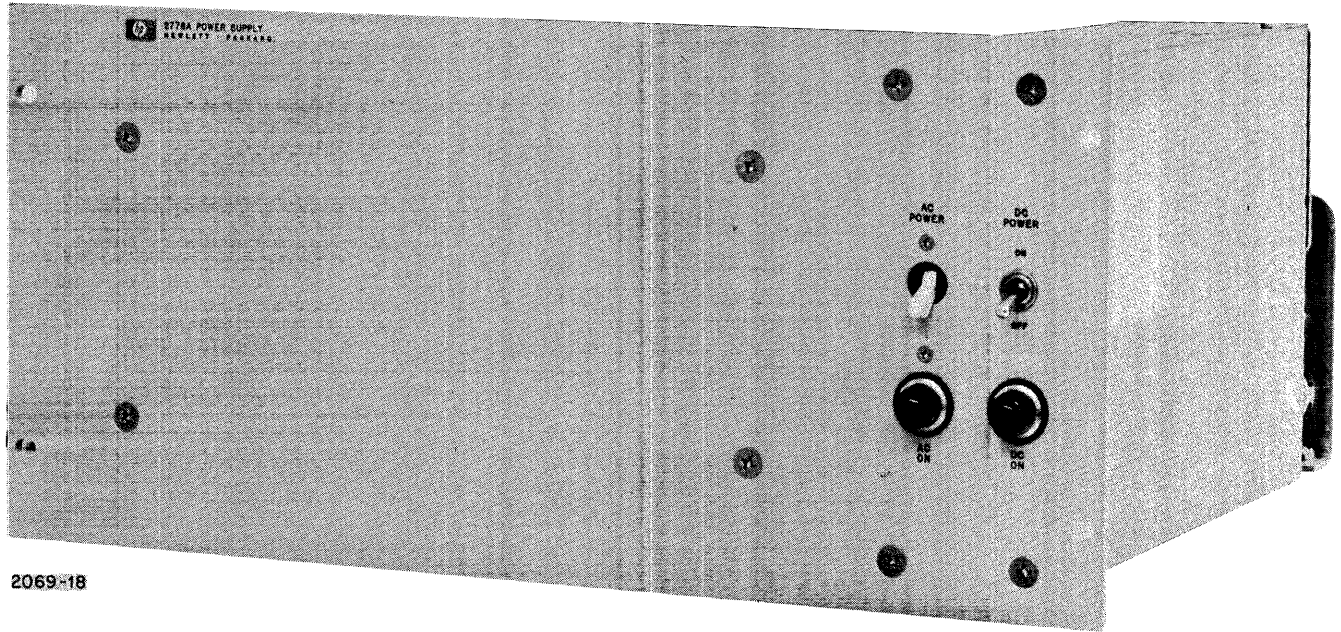

2069-18

Figure 2-27. HP 2776A Power Supply

Table 2-14. HP 2776A Power Supply Specifications

DESCRIPTION:	Power Supply for HP 2773A and HP 2774A Drum Memories
WEIGHT:	50 pounds
CURRENT DRAIN:	16 amps starting, 3 amps running at 115 volts ac
HEAT DISSIPATION:	1200 BTU/hour

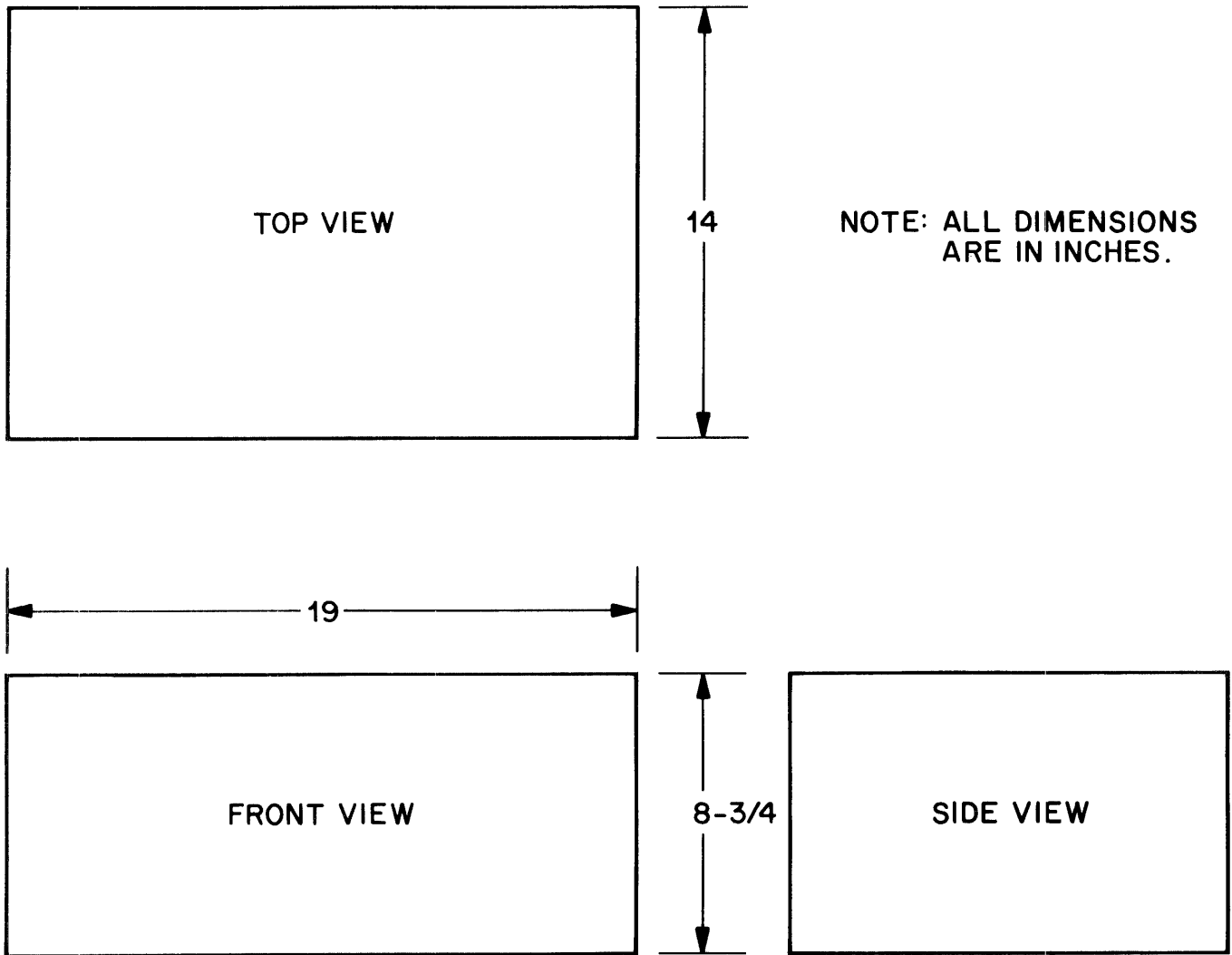

2069-30

Figure 2-28. HP 2776A Power Supply Outline Drawing

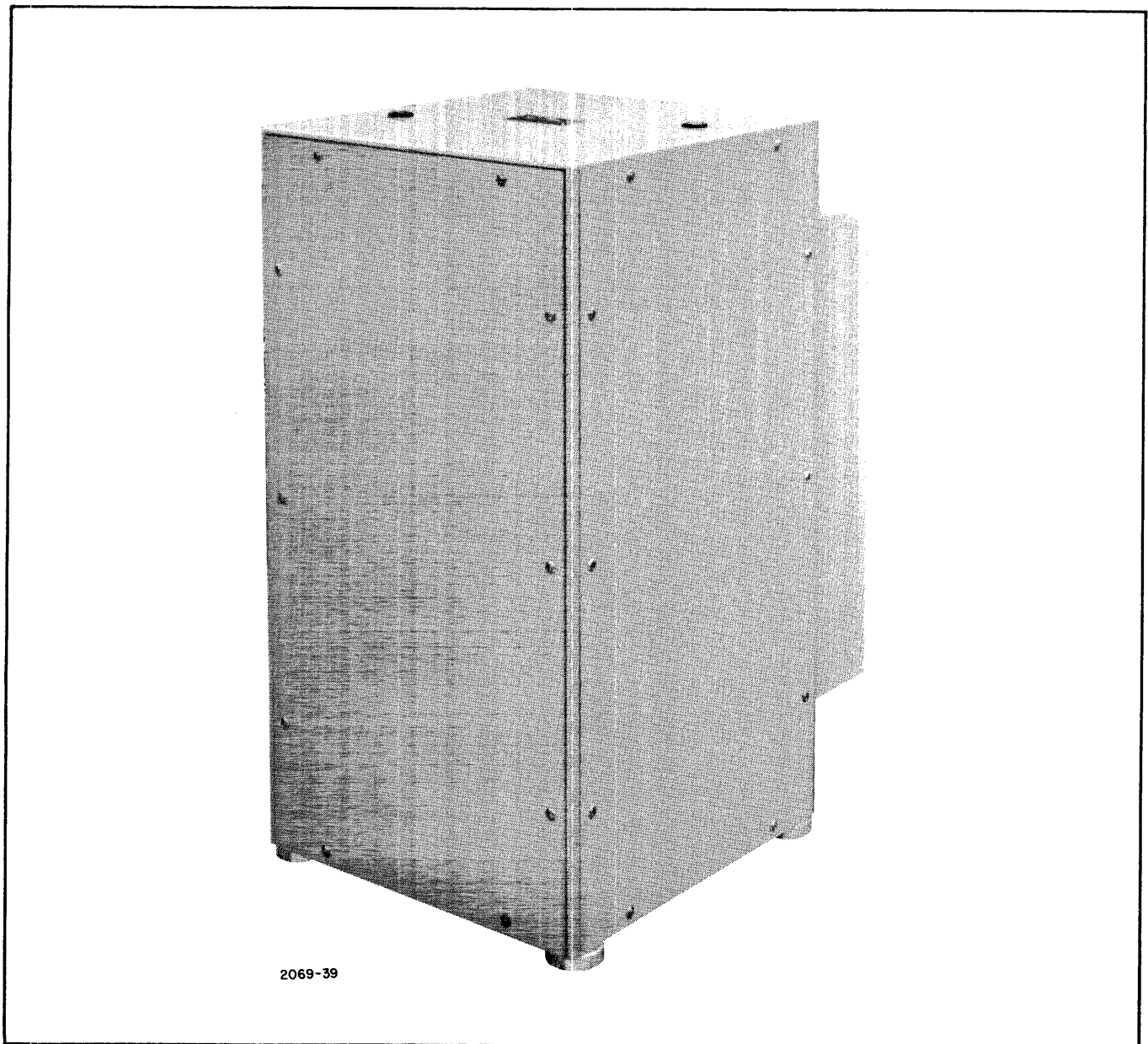
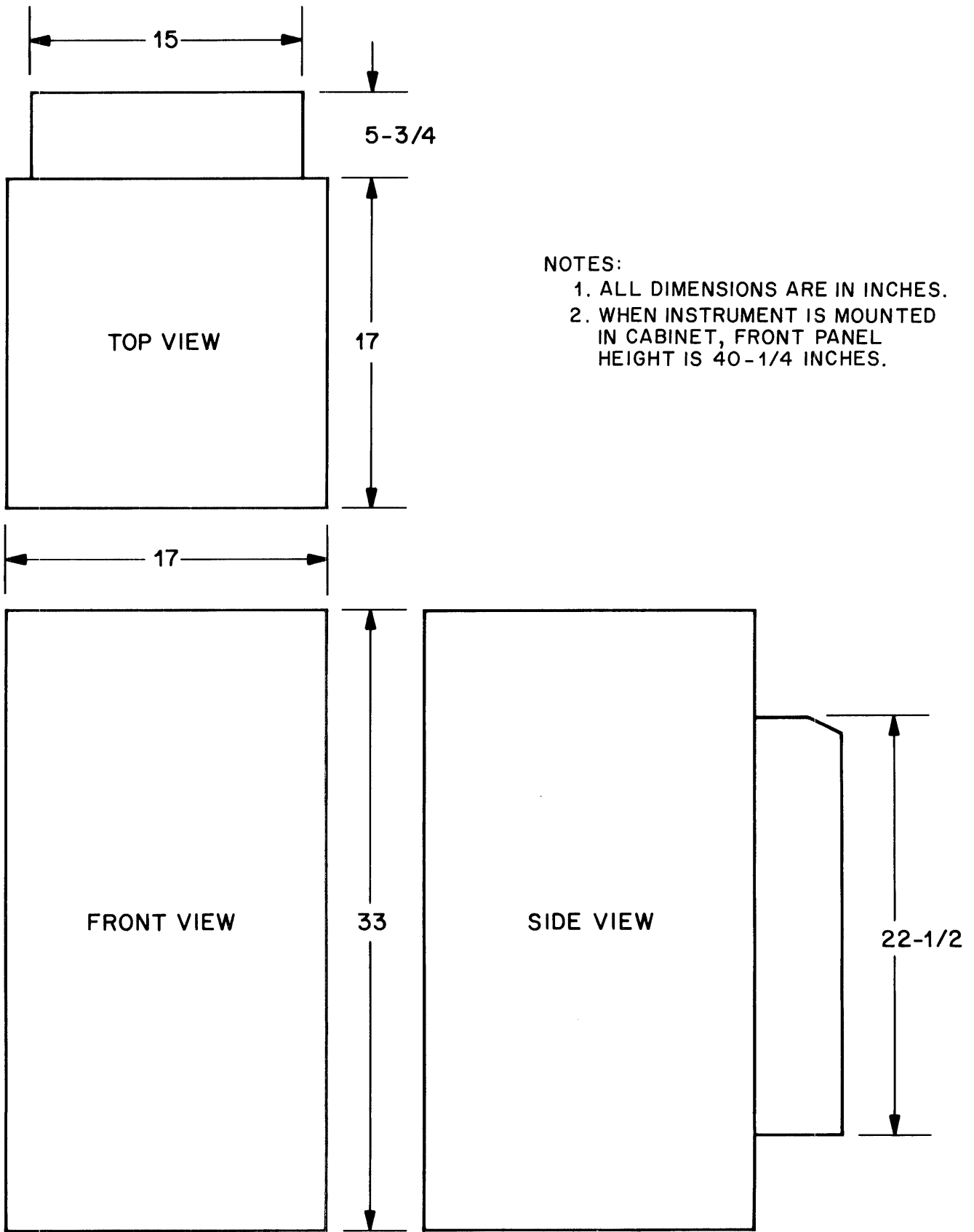

Figure 2-29. HP 2775A Drum Memory

Table 2-15. HP 2775A Drum Memory Specifications

DESCRIPTION:	Additional drum memory storage with a capacity of 1,572,864 words
WEIGHT:	300 pounds
CURRENT DRAIN:	Included with HP 2777A Power Supply current
HEAT DISSIPATION:	Included with HP 2777A Power Supply heat dissipation
SIGNAL CABLE LENGTH:	10 feet



2069-31

Figure 2-30. HP 2775A Drum Memory Outline Drawing



2069-17

Figure 2-31. HP 2777A Power Supply

Table 2-16. HP 2777A Power Supply Specifications

DESCRIPTION:	Power supply for HP 2775A Drum Memory
WEIGHT:	50 pounds
CURRENT DRAIN:	16 amps starting, 6 amps running (120/208-volt, 3-phase power)
HEAT DISSIPATION:	2400 BTU/hour

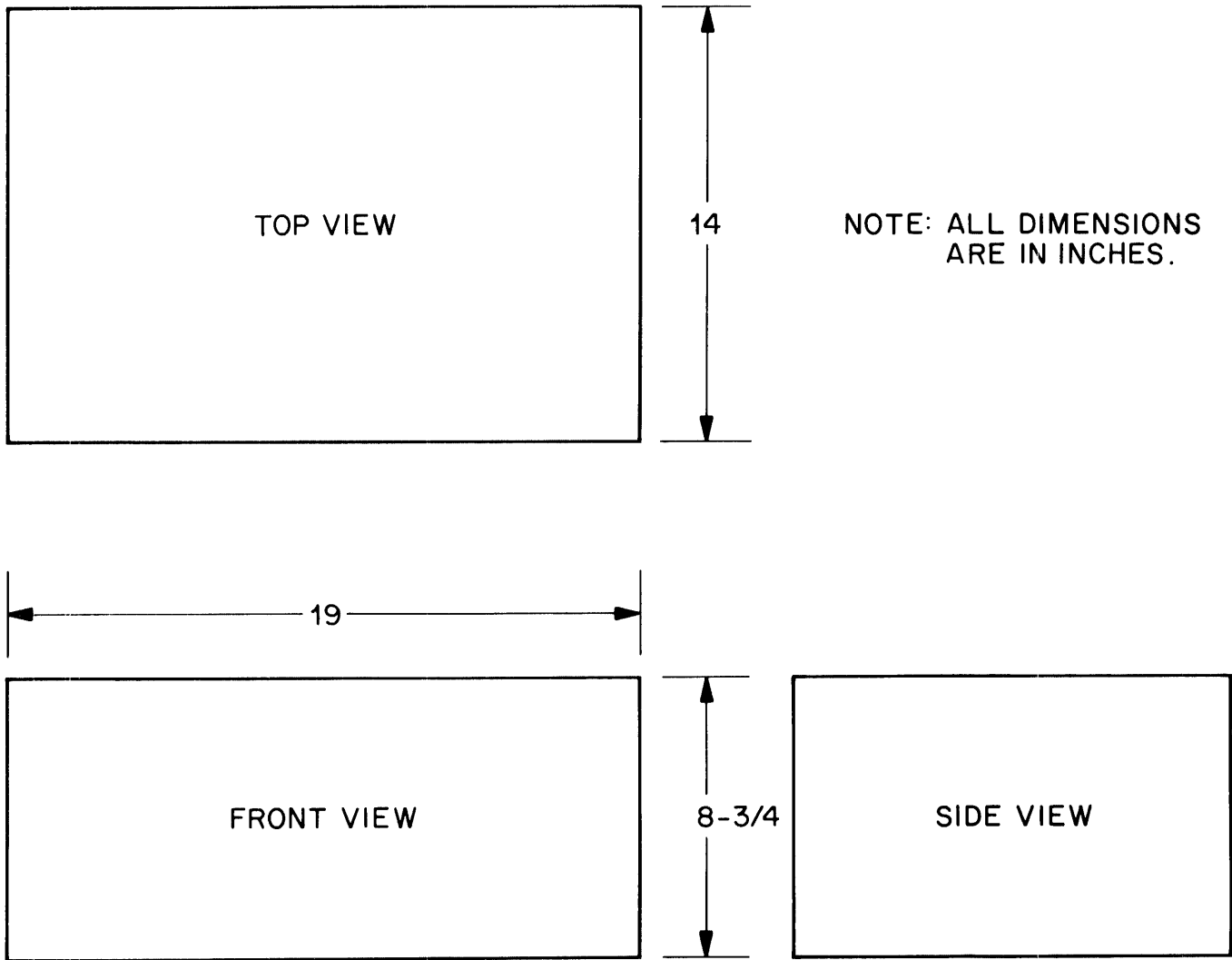

2069-30

Figure 2-32. HP 2777A Power Supply Outline Drawing

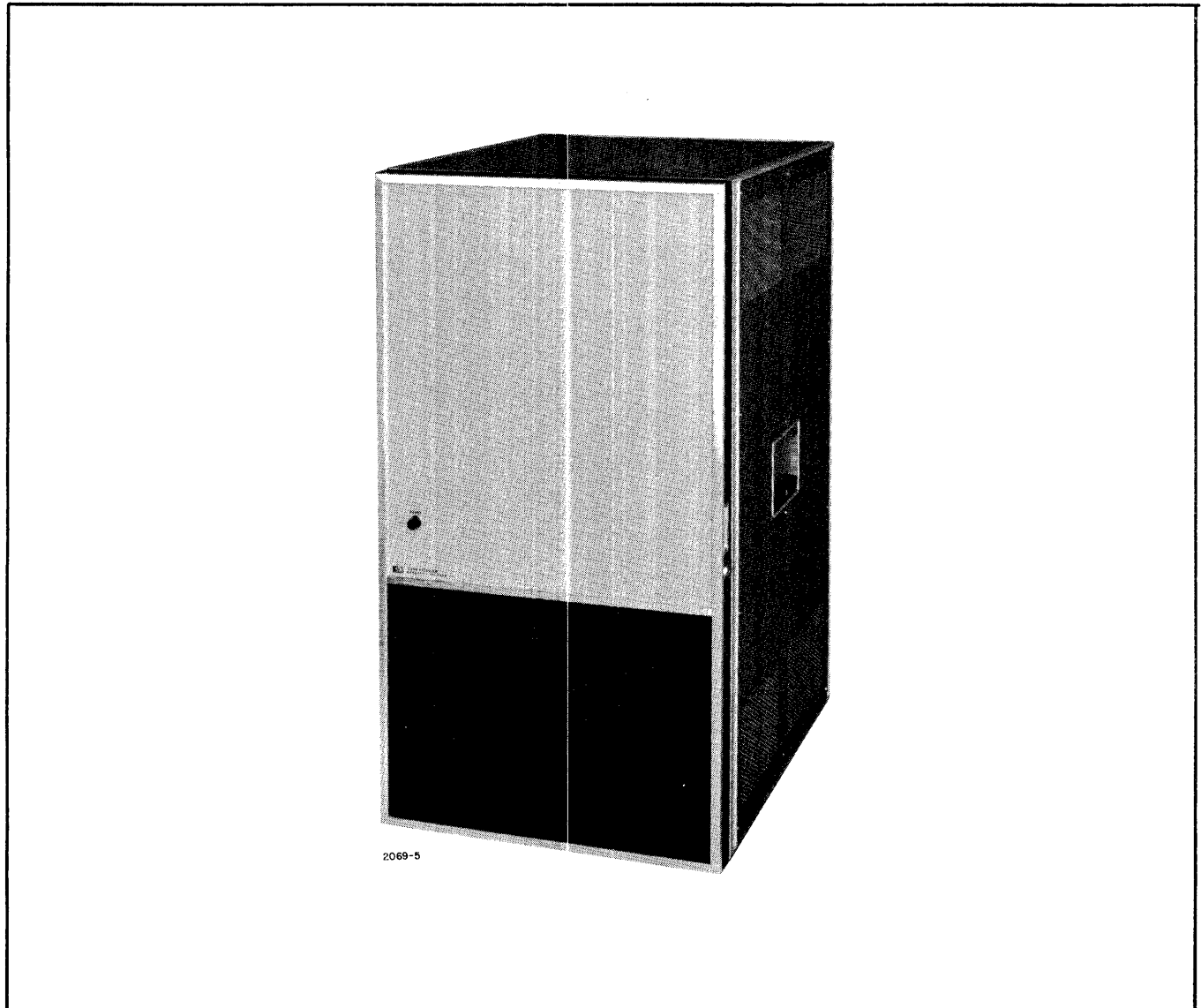
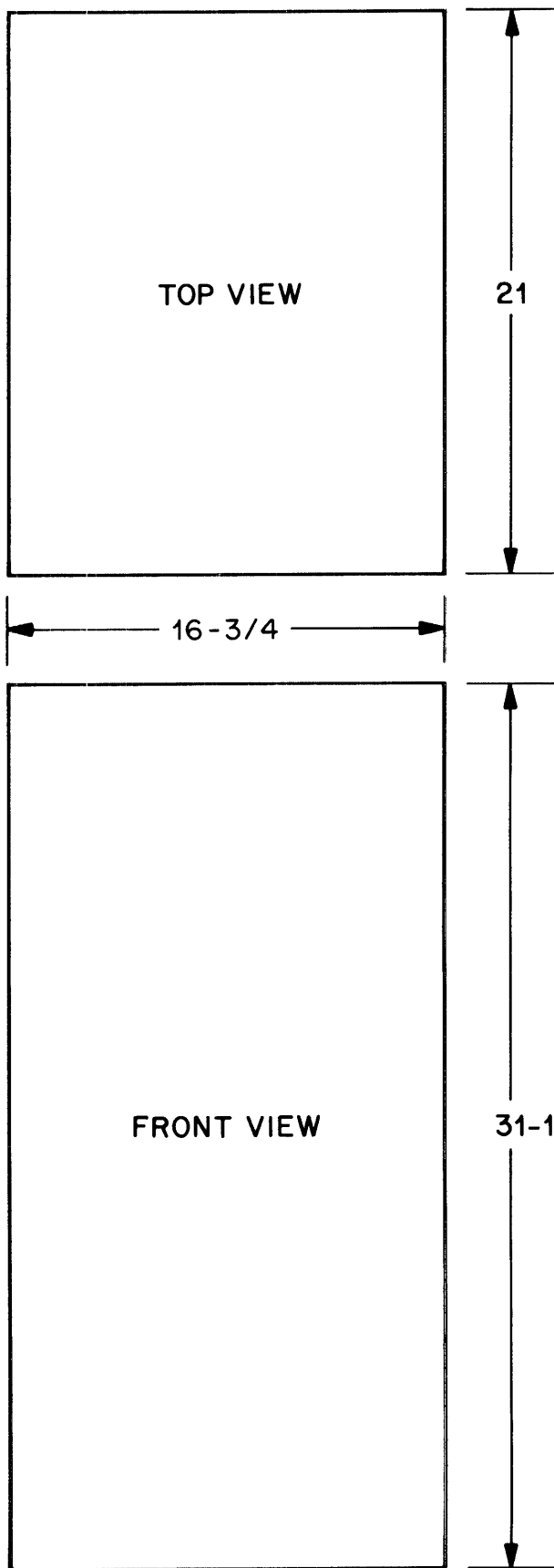

Figure 2-33. HP 2150B Extender

Table 2-17. HP 2150B Extender Specifications

DESCRIPTION:	Provides additional input/output and memory capability for the computer.
WEIGHT:	200 pounds
CURRENT DRAIN:	5 amps at 115 volts ac
HEAT DISSIPATION:	2000 BTU/hour
SIGNAL CABLE LENGTH:	25 feet



- NOTES:
1. ALL DIMENSIONS ARE IN INCHES.
 2. RACK MOUNTING KIT NO. 5060-6236 INCREASES THE WIDTH OF THE INSTRUMENT TO 19 INCHES.

2069-21

Figure 2-34. HP 2150B Extender Outline Drawing

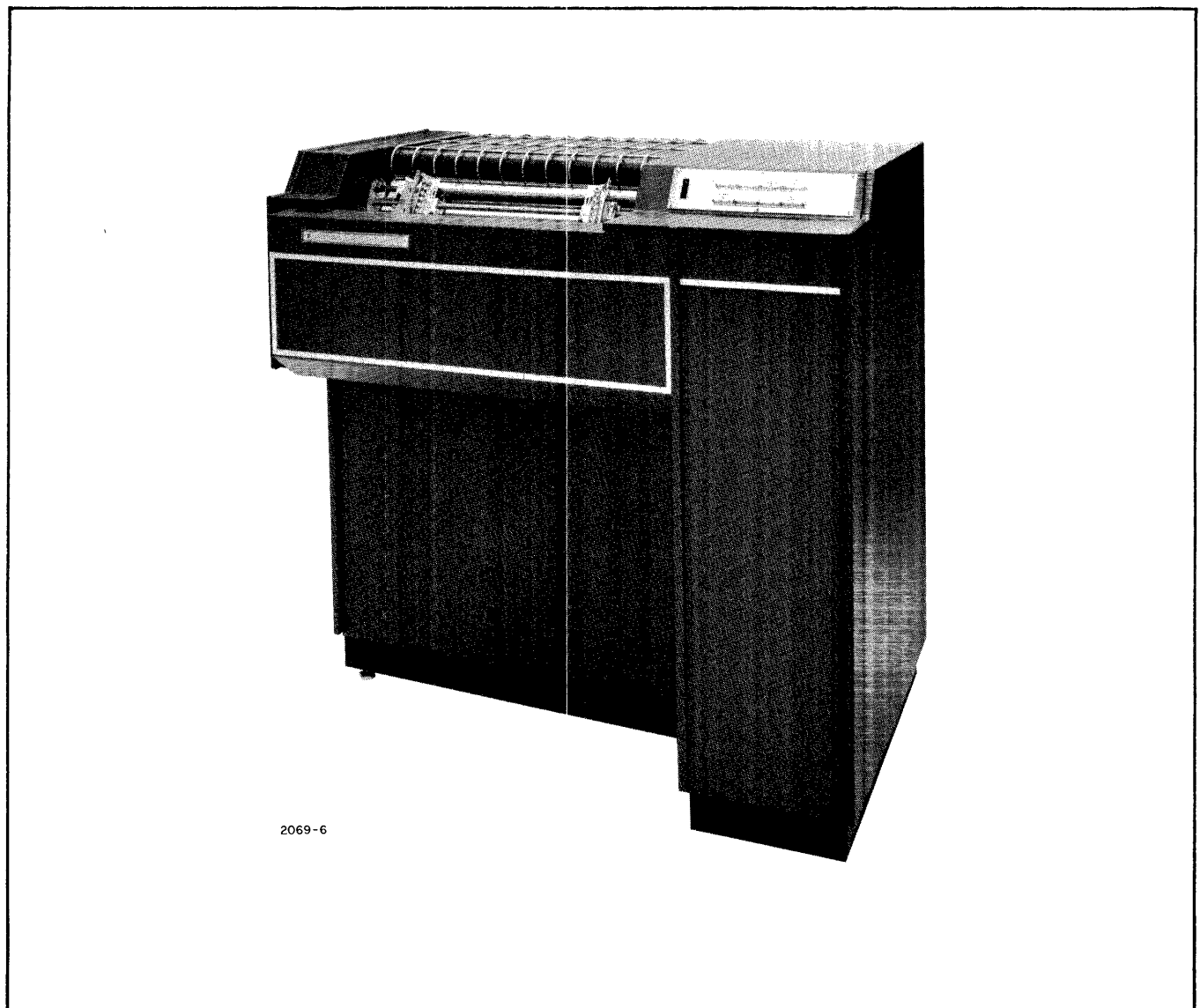
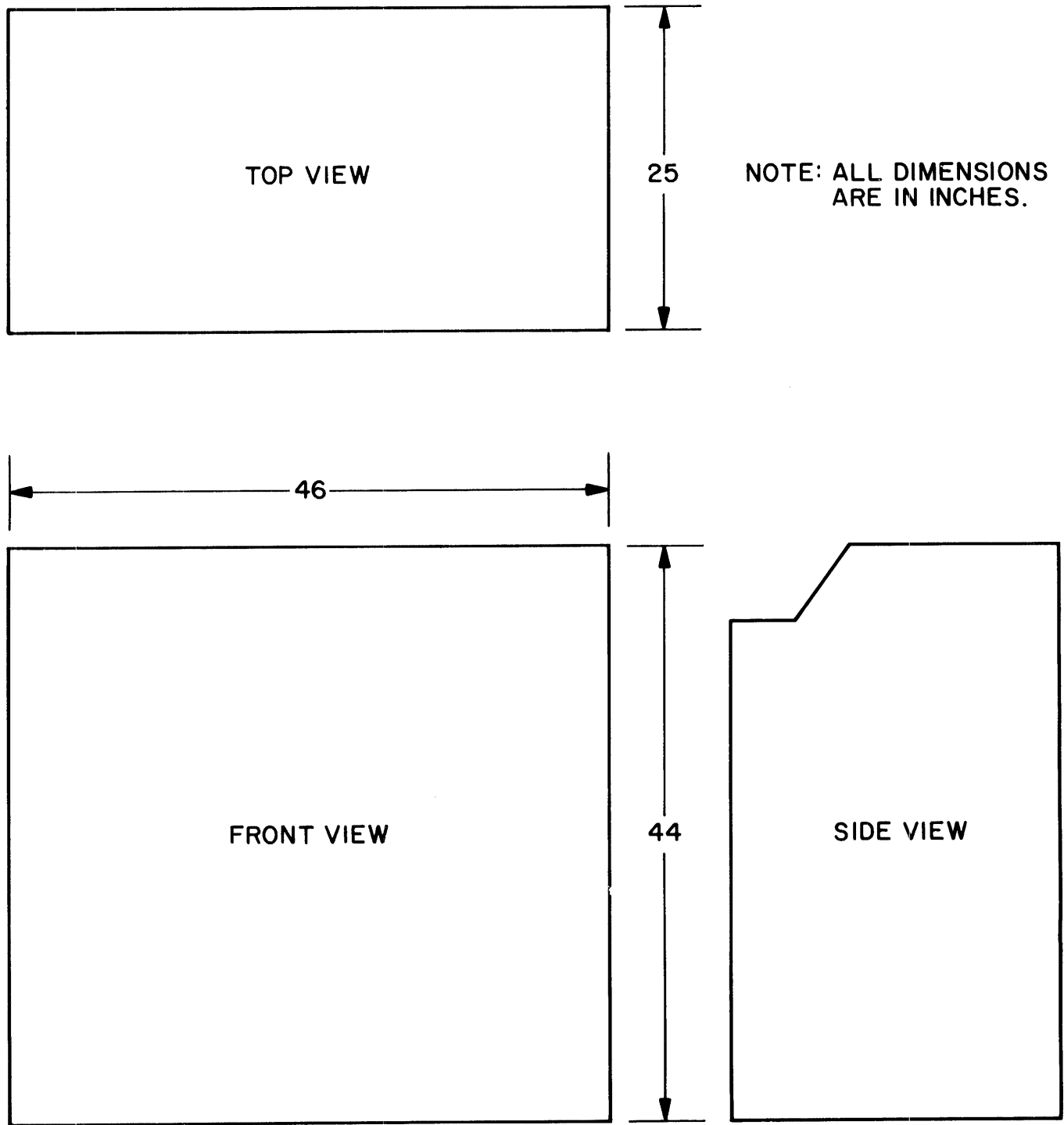

Figure 2-35. HP 2778A Line Printer

Table 2-18. HP 2778A Line Printer Specifications

DESCRIPTION:	Provides a typed print-out of coded data at a rate of 300 lines per minute
WEIGHT:	850 pounds
CURRENT DRAIN:	9 amps at 115 volts ac
HEAT DISSIPATION:	3500 BTU/hour
SIGNAL CABLE LENGTH:	25 feet



2069-32

Figure 2-36. HP 2778A Line Printer Outline Drawing

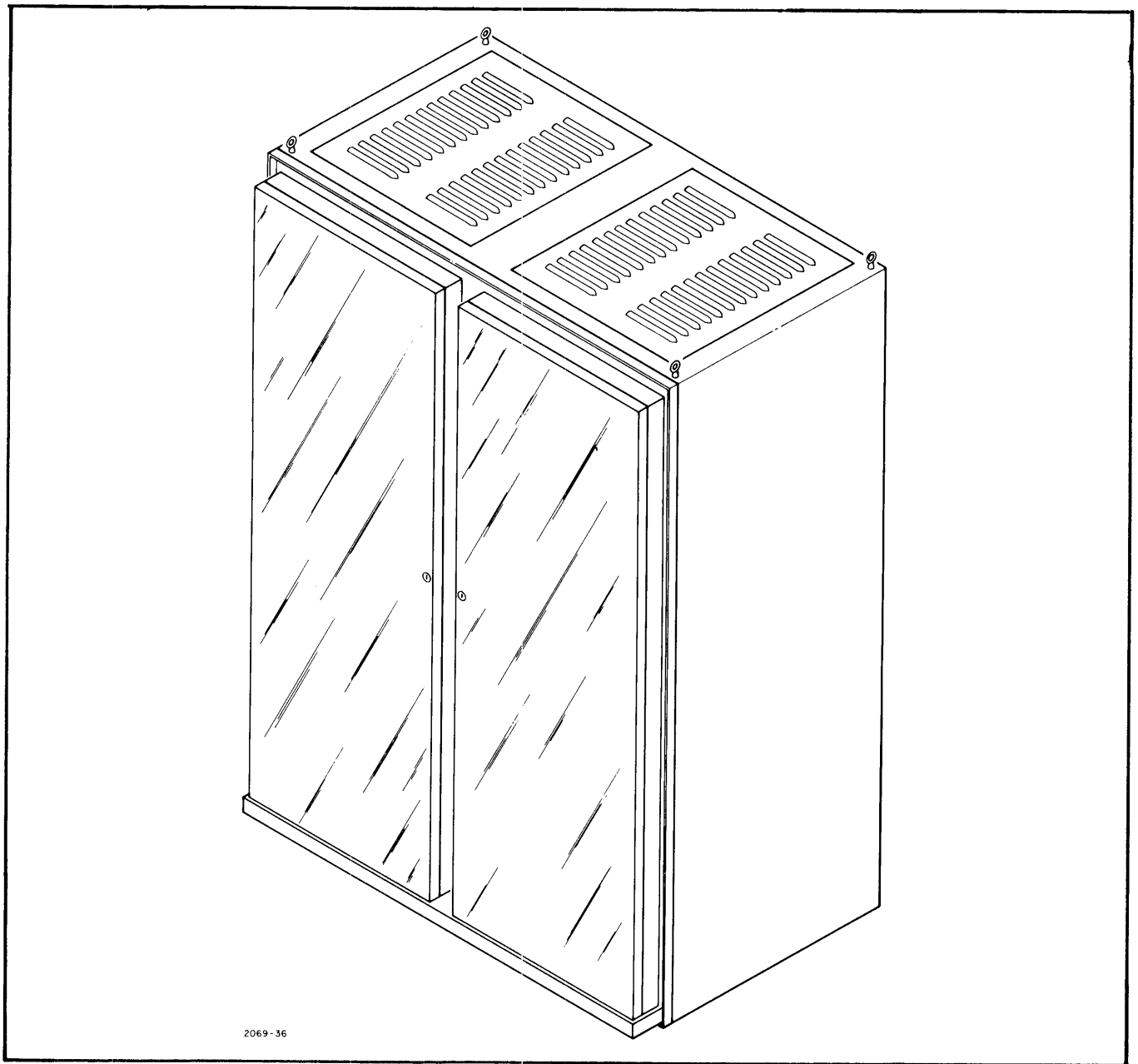
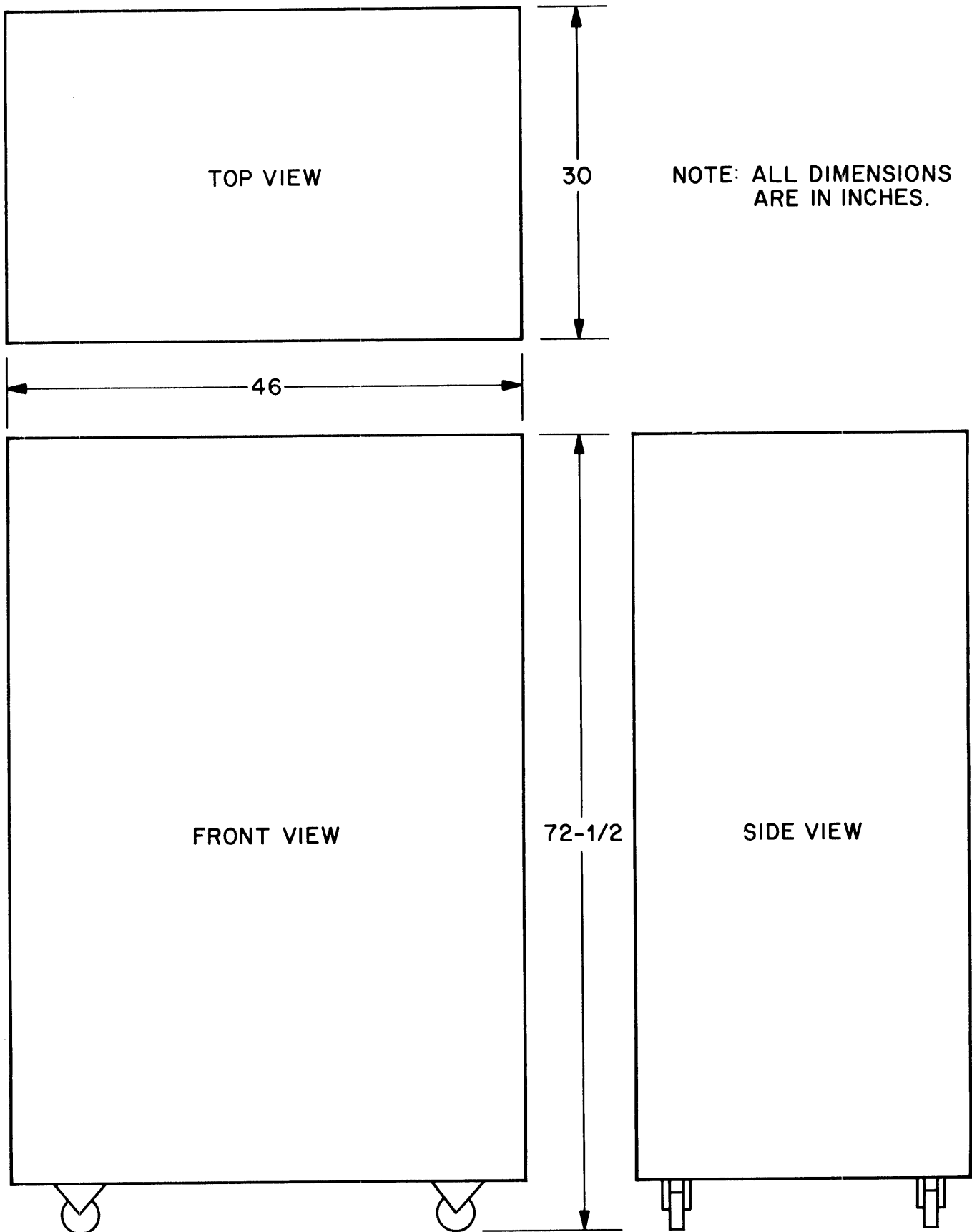

Figure 2-37. HP 2992Z Two-Bay Cabinet

Table 2-19. HP 2992Z Two-Bay Cabinet Specifications

DESCRIPTION:	Cabinet for housing system equipment
WEIGHT:	475 pounds
CURRENT DRAIN:	1.6 amps at 115 volts ac (includes fans only)
HEAT DISSIPATION:	negligible



2069-33

Figure 2-38. HP 2992Z Two-Bay Cabinet Outline Drawing

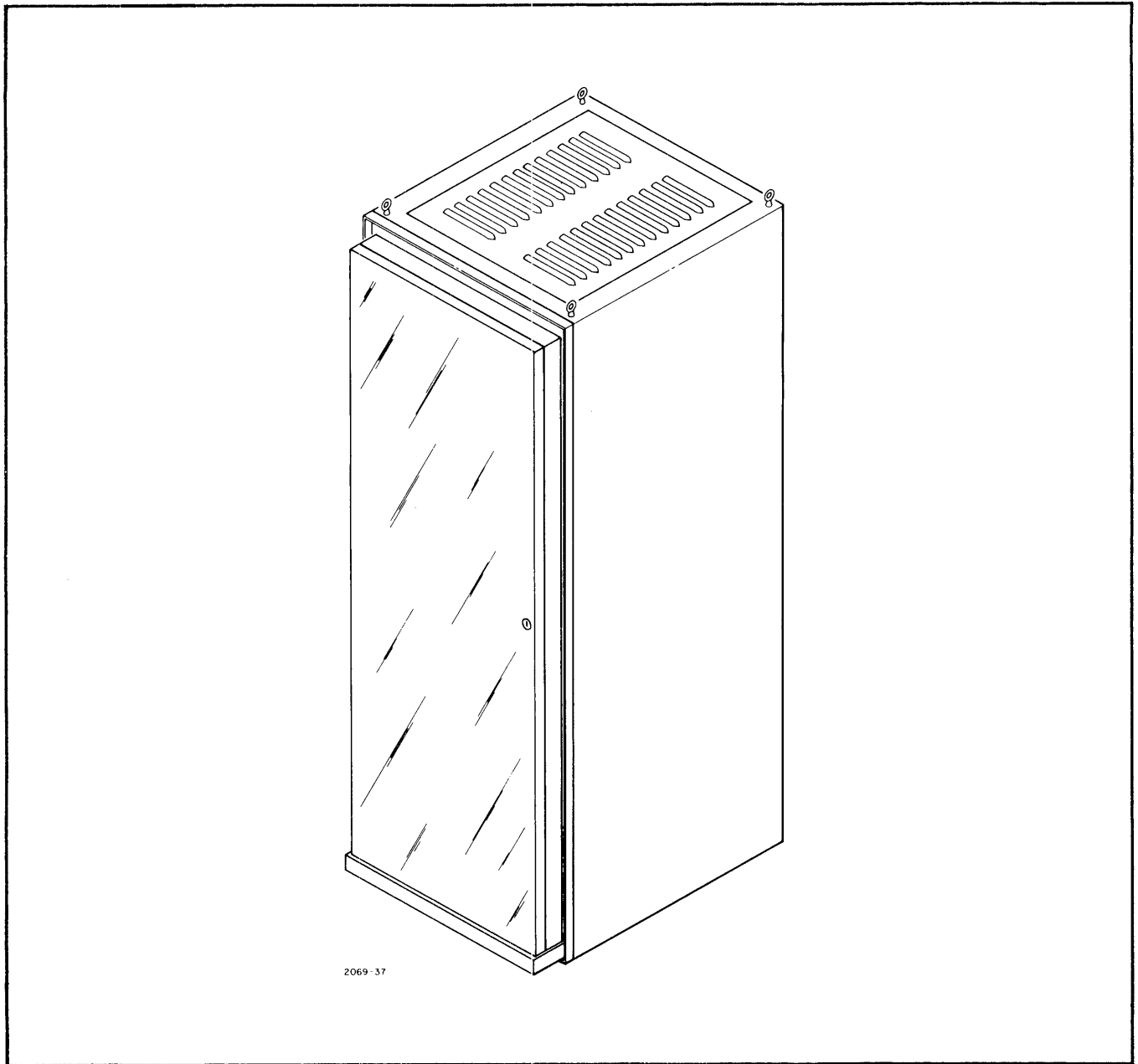
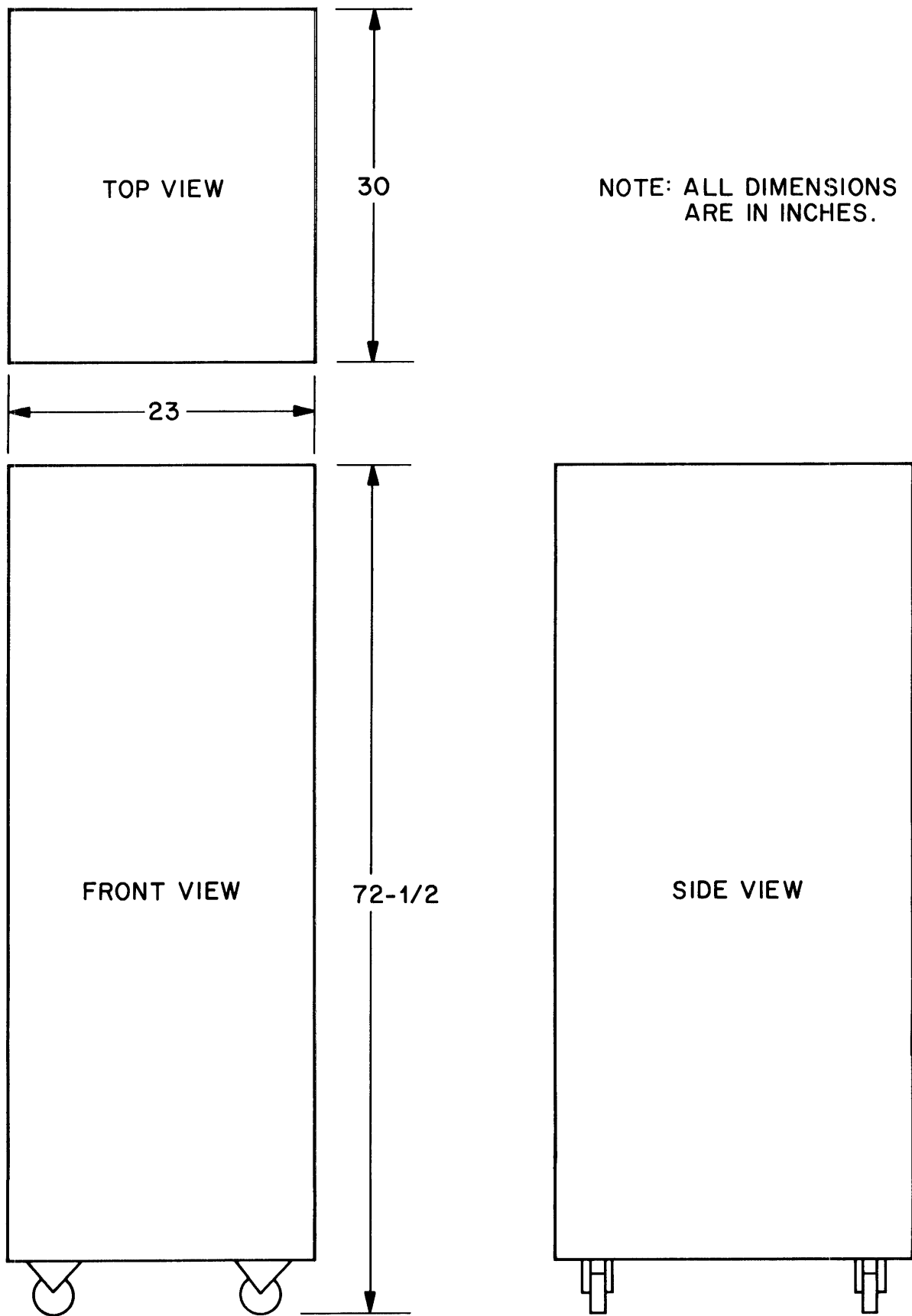

Figure 2-39. HP 2866A Extender Cabinet

Table 2-20. HP 2866A Extender Cabinet Specifications

DESCRIPTION:	Cabinet for housing additional system equipment
WEIGHT:	200 pounds
CURRENT DRAIN:	0.8 amp at 115 volts ac (includes fans only)
HEAT DISSIPATION:	negligible



2069-34

Figure 2-40. HP 2866A Extender Cabinet Outline Drawing

Table 2-21. System Accessories

QUANTITY	MODEL OR PART NUMBER	EQUIPMENT NAME	DESCRIPTION
1	12597A	Tape Punch Interface	Interfaces the tape punch with the computer.
1	12578A	Direct Memory Access	Transfers data directly between computer memory and external devices at a maximum rate of 625,000 16-bit words per second.
1	12579A	Extended Arithmetic Unit	Allows multiply, divide, and other arithmetic operations to be performed by hardware.
1	12588A	Power Fail with Auto Restart	Saves the memory and register contents of the computer when power fails.
1	12591A	Memory Parity Check	Halts or interrupts computer operation whenever a parity error occurs.
1	12539A	Time Base Generator	Provides a time base for determining time of day, for measuring system usage, and for timing the sharing of program execution time.
1	12532A	Tape Reader Interface Kit	Interfaces the tape reader with the computer.
1	12531B	Teleprinter Input/Output Interface Kit	Interfaces the teleprinter with the computer.
1-4	12606B	Disc Memory Interface Kit	Interfaces the disc memory with the computer.
1-16	12584-6007	Teleprinter Extender Cable	Connects HP 2749A Teleprinter terminal to multiplexor. Lengths of 25 feet to 1 mile are available.
1-16	12584-6006	Data Set Cable	Connects a Bell System 103A Data Set to the teleprinter multiplexor.
1	12559A	Magnetic Tape Input/Output Interface Kit	Interfaces the magnetic tape unit with the computer.
1-4	12610A	Drum Memory Interface Kit	Interfaces the drum memory with the computer.
1	12617A	Line Printer Interface	Interfaces the line printer with the computer

SECTION III

SYSTEM POWER DISTRIBUTION

3-1. INTRODUCTION.

3-2. This section contains power distribution diagrams for the HP 2000A Time-Shared BASIC System. These diagrams provide detailed information to allow the customer to anticipate the power connections to be made when the system is installed.

3-3. POWER DISTRIBUTION DIAGRAMS.

3-4. The following pages contain power distribution diagrams for the system. Figure 3-1 is the wiring diagram for the HP 2992Z Two-Bay Cabinet. Figure 3-2 is the wiring diagram for the HP 2866A Extender Cabinet.

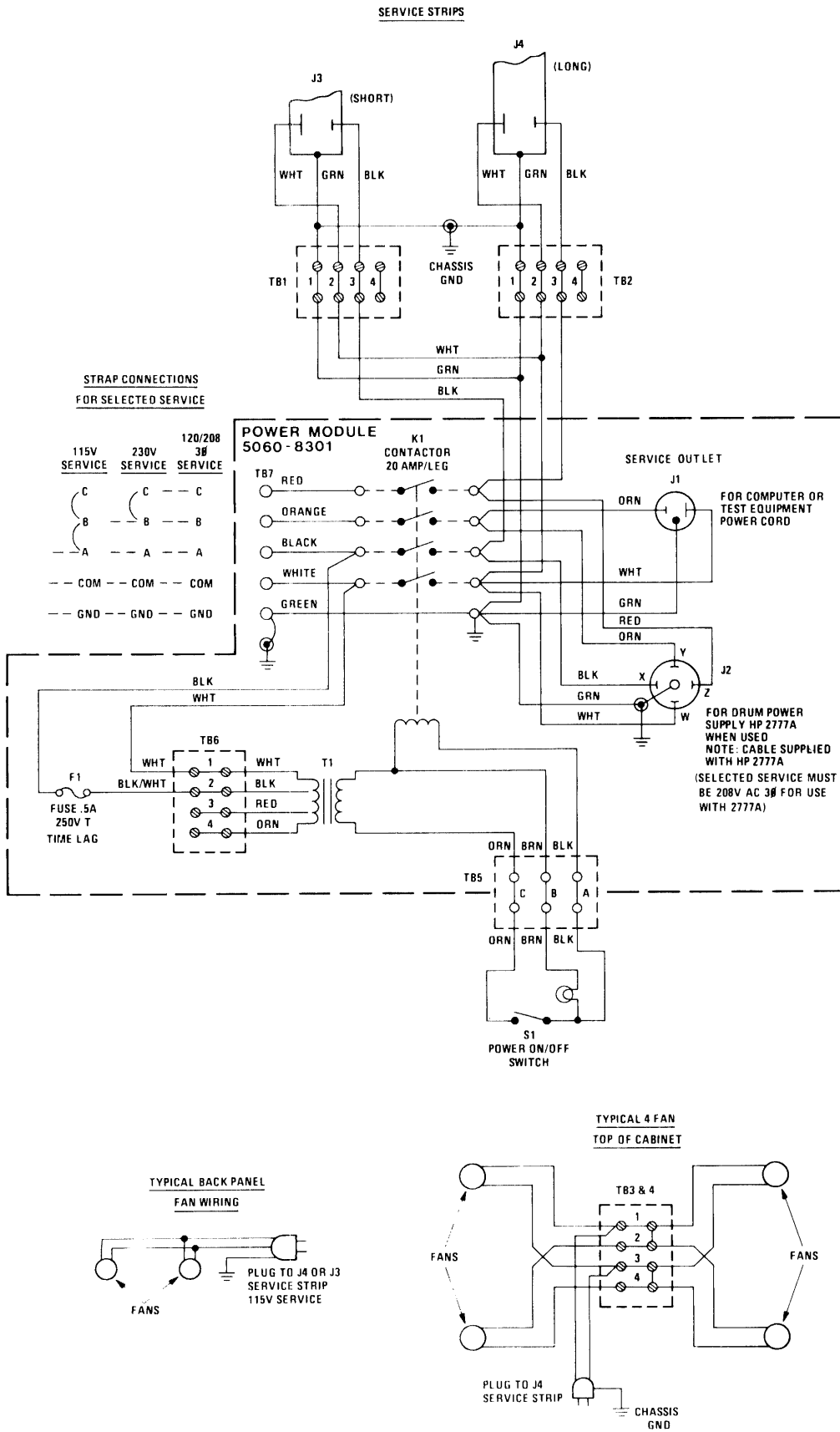

Figure 3-1. HP 2992Z Two-Bay Cabinet Wiring Diagram

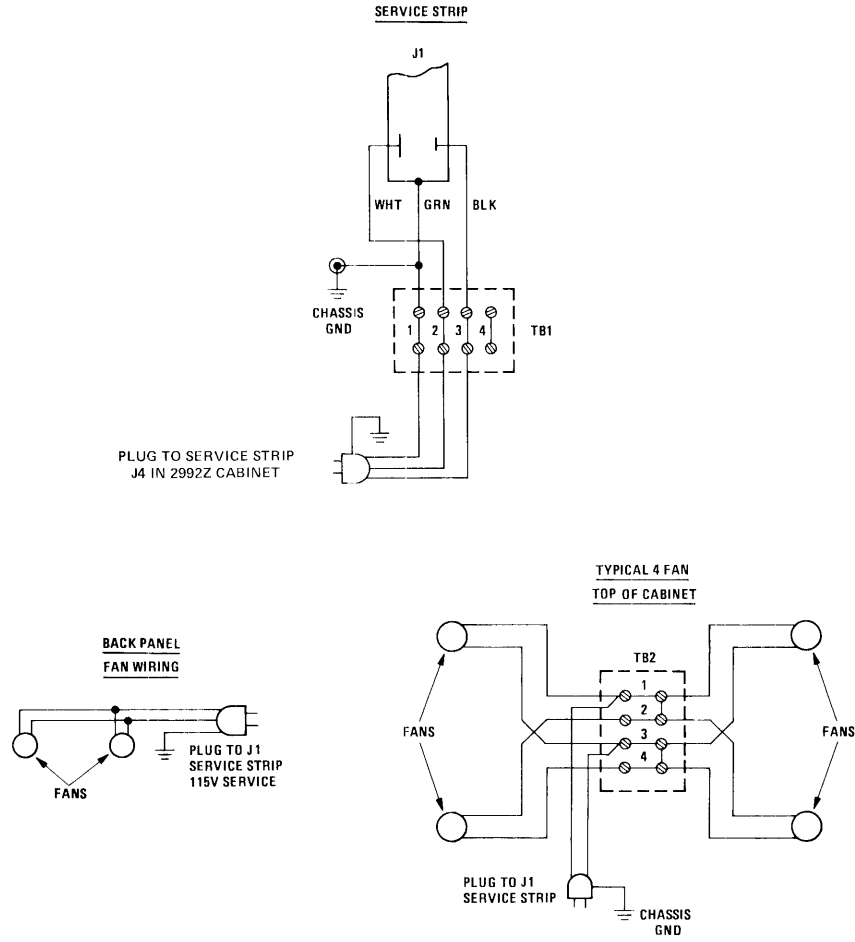

Figure 3-2. HP 2866A Extender Cabinet Wiring Diagram